

Innovative sign solutions for the Library industry

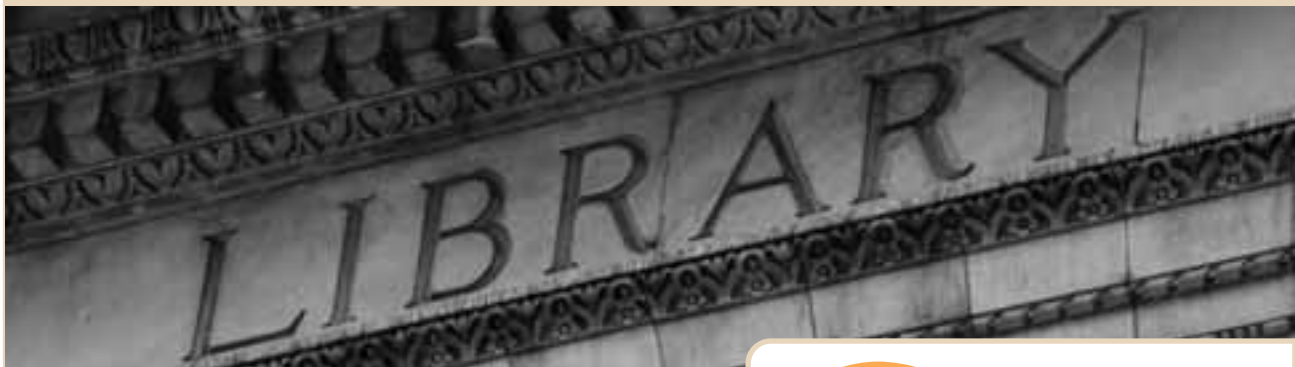

We do it your Wayfinding

## Cover to cover signage solutions



**Vista**  **Library** <sup>line</sup>  
Cover to cover signage solutions

650  
Management & auxiliary  
services

Jazz

Author of the month  
Book Review: May 2011

Welcome to the world of books!

We don't sell or lend books – this is done by bookstores and libraries. We design and create the signage systems that help you find your way inside the libraries.

Vista System is the first in the world to offer a unique line of signage products designed specifically for libraries. Vista Library Line is a world of wayfinding products that were created with only one focus in mind: the specific wayfinding needs of libraries from A to Z.

There is no need to look further: a whole solution for libraries' signage is finally here!

### Table of Contents:

Main Entrance Directing .....	1-16
Departments' Entrance .....	17-28
Book Stands .....	29-40
Shelf Dividers .....	41-44
Dewey Decimal System .....	45-54
Librarian Position .....	55-60
Instructional Signs .....	61-66
Wayfinding .....	67-91
Facilities .....	92-114
Warning Signs .....	115-142
Emergency signs .....	143-150
Toilet Signs .....	151-164
Computers and Internet .....	165-186
Magazines .....	187-190
Music and Video .....	191-202
Children's Department .....	203-210
Contributors signs .....	211-219
Tough signs for busy environments .....	220



MCFT Modular Curved Frame Technology

# Main Entrance Directing

We begin at the entrance – one of the most important areas of the library. Here you can choose from a variety of sign types designed specifically for entrances.

A typical library has a plethora of information to display to its visitors immediately when they enter the premises. The entrance is the ideal place to display such information. Codes of behavior in the library, operating hours, maps, news, and events are among the most common types of information to be displayed at the entrance. The information should be displayed in a clear and respectable manner.

Choose the right product for you and order today from your preferred Vista System sign dealer.





Opening Hours

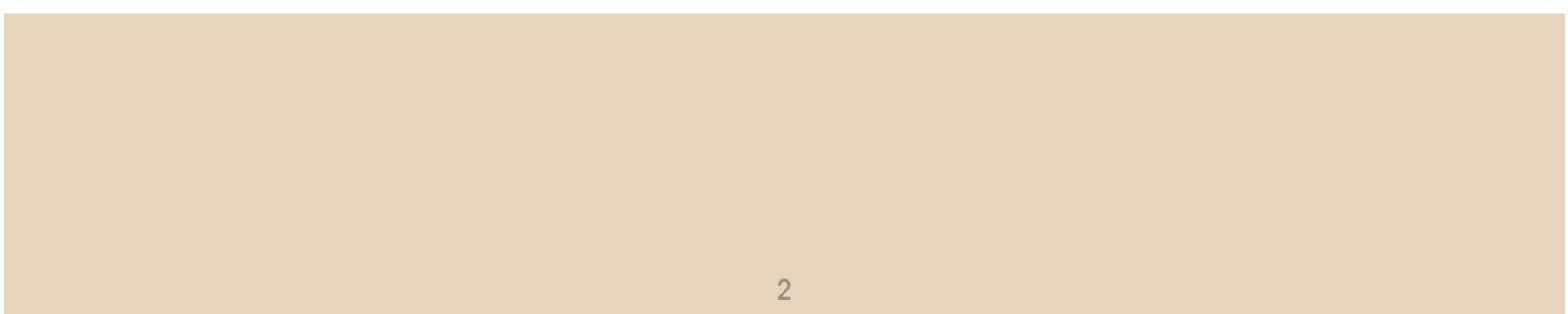

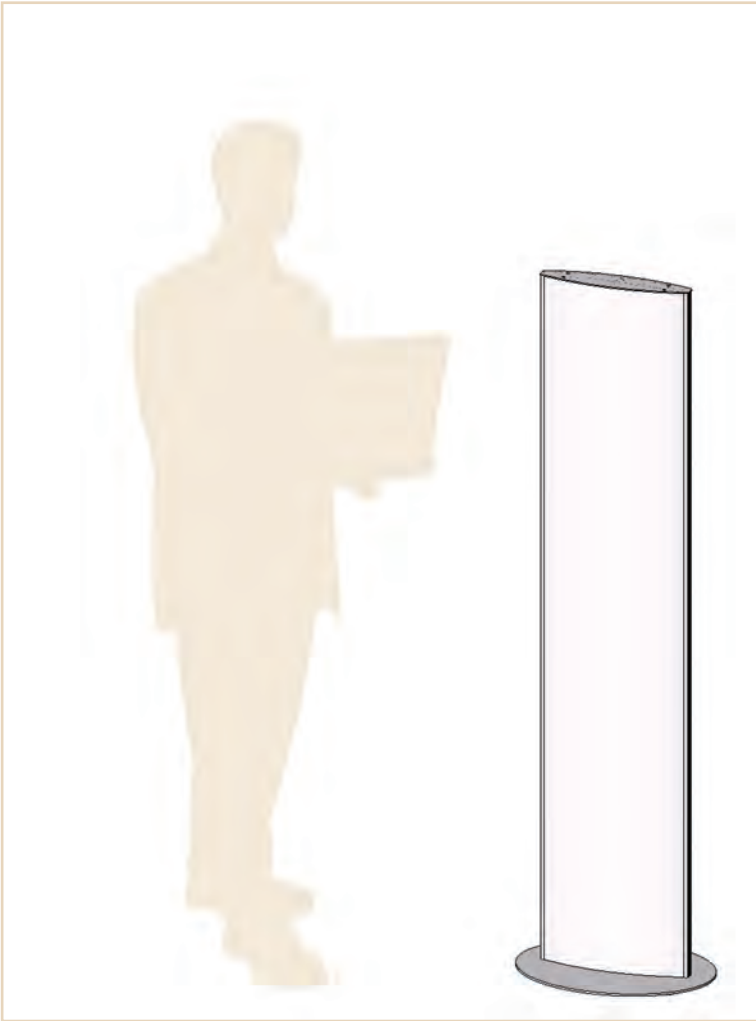

### Opening Hours

#### SECT0037

Overall sign size: H 51.6" x W 11.2"  
H 1310mm x W 284.5mm

Insert size: 51.18" x 10.98" (1300mm x 279mm)

■ A freestanding pylon is ideal for displaying the library's operating hours in an eye catching and stylish fashion. Updating is quick and easy: just remove the printed insert and replace it with a new one. Braille inserts are supported.



Library Map



### Library Map

**SECT0039**

Overall sign size: H 63.5" x W 36"  
H 1615mm x W 915mm

Insert size: 63" x 35.9" (1600mm x 912mm)

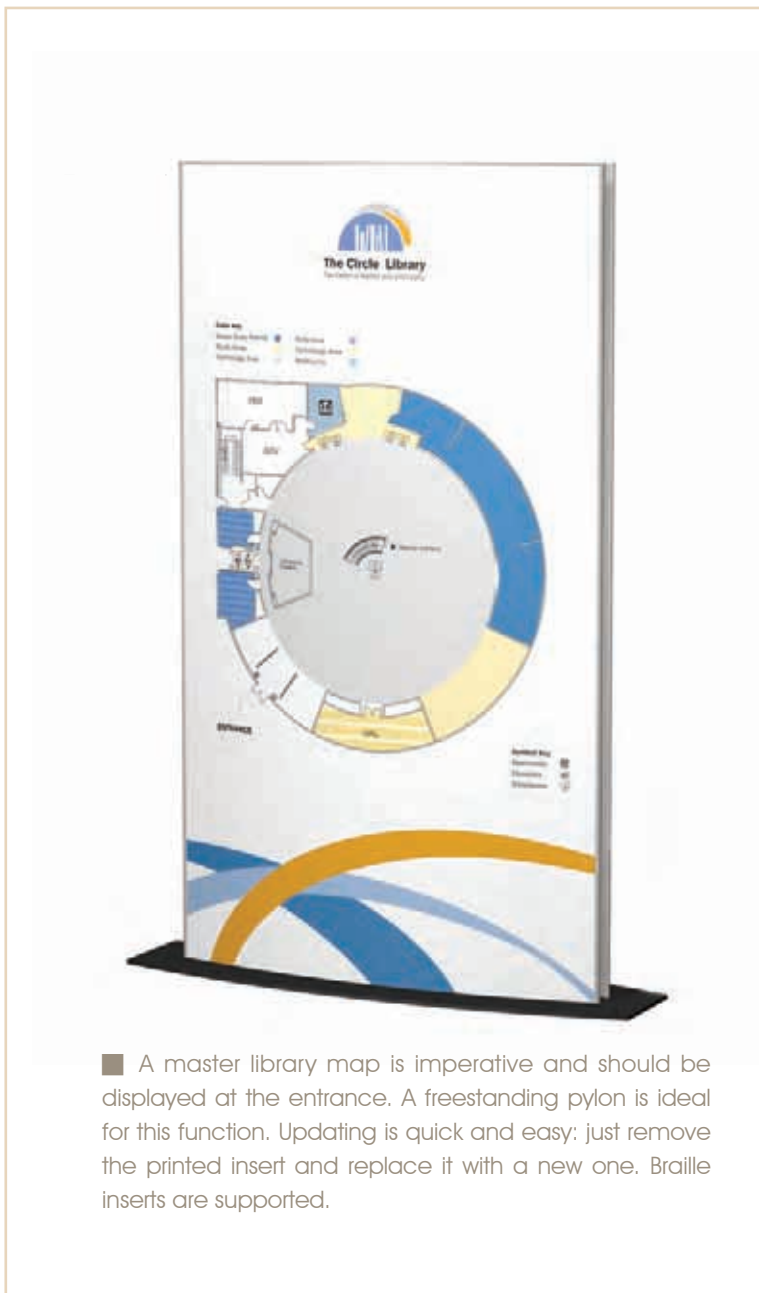

■ A master library map is imperative and should be displayed at the entrance. A freestanding pylon is ideal for this function. Updating is quick and easy: just remove the printed insert and replace it with a new one. Braille inserts are supported.



Opening Hours

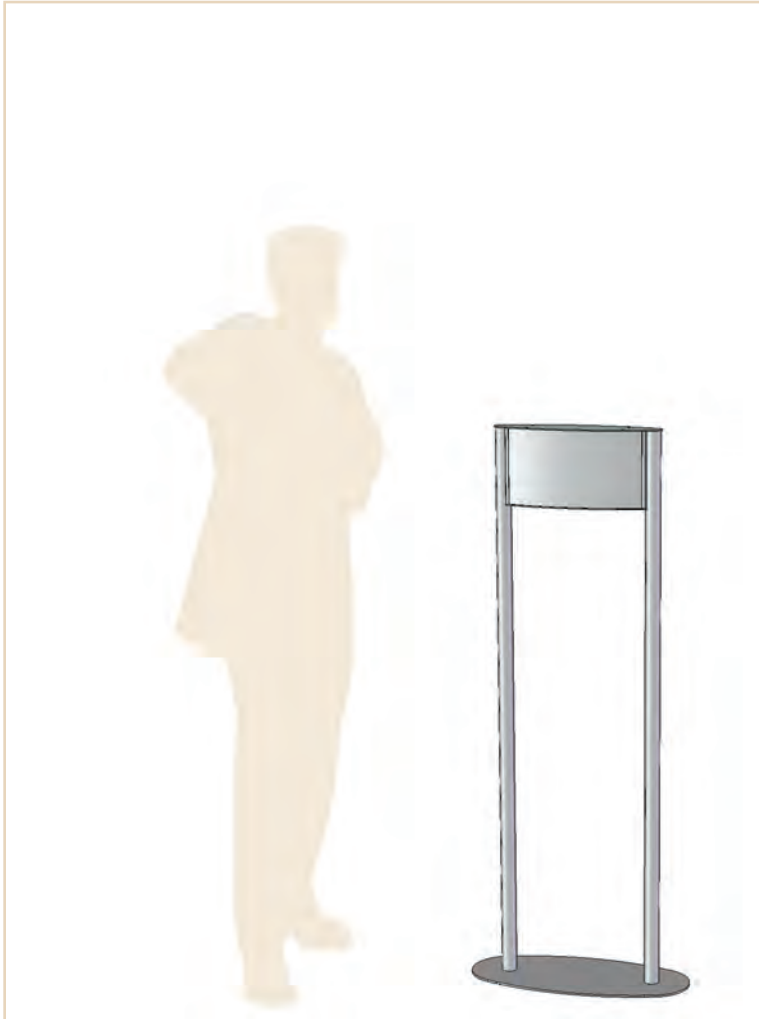

## Opening Hours

### SECT0001

Overall sign size: H 44.4" x W 13.25"  
H 1130mm x W 456mm

Insert size: 7.638" x 10.984" (194mm x 279mm)

■ A freestanding post pylon is ideal for displaying the library's operating hours in an eye catching and stylish fashion. Updating is quick and easy: just remove the printed insert and replace it with a new one. Braille inserts are supported.



Storytelling Hours

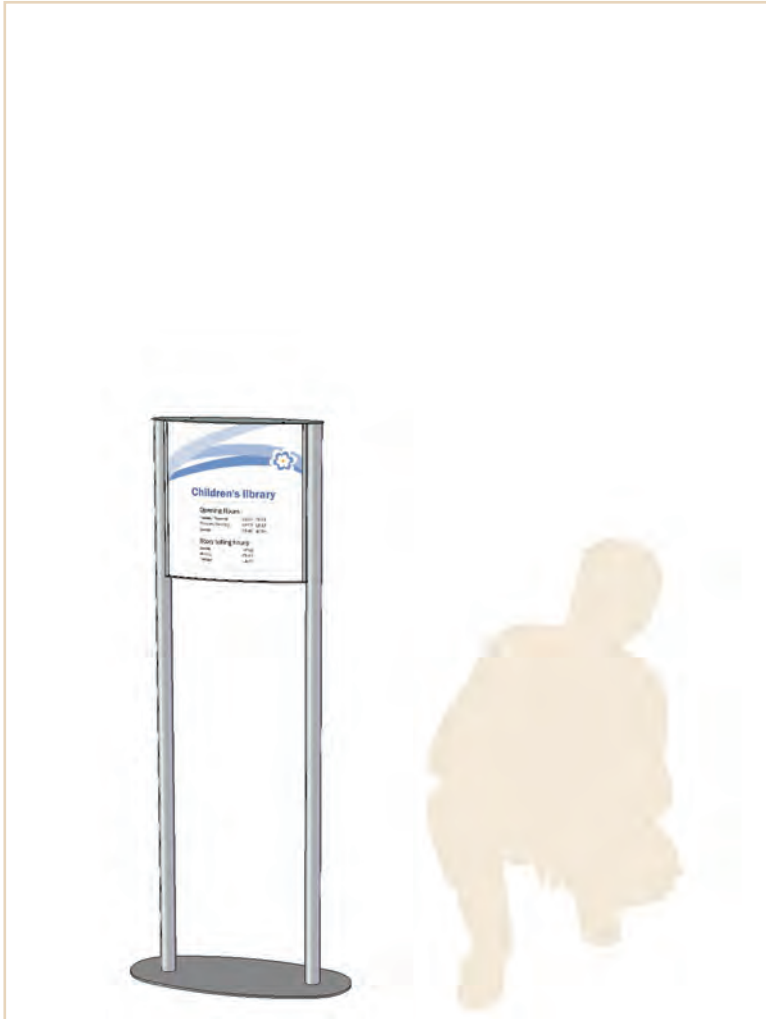

## Storytelling Hours

### SECT0002

Overall sign size: H 44.4" x W 13.25"

H 1130mm x W 456mm

Insert size: 11.81" x 10.98" (300mm x 279mm)

■ A freestanding post pylon is ideal for displaying the library's opening hours in an eye catching and stylish fashion. Updating is quick and easy; just remove the printed insert and replace it with a new one. Braille inserts are supported.



Operating Hours/Library Map

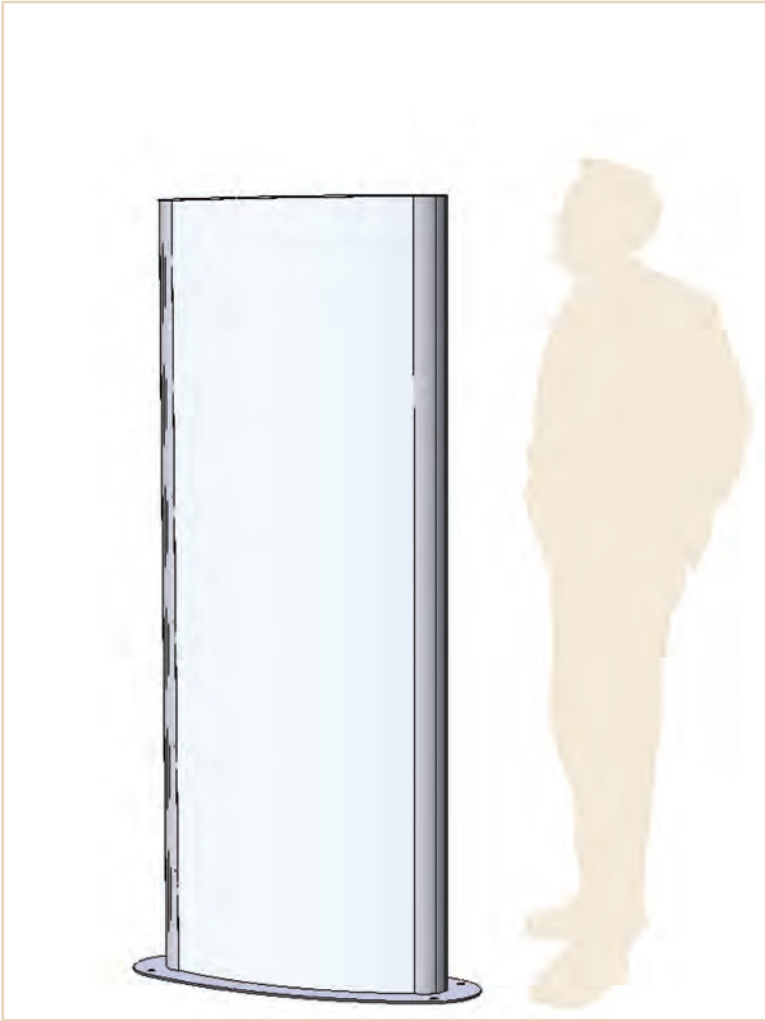

### Operating Hours/Library Map

#### VLF18

Overall sign size: H 69.3" x W 27"  
H 1760mm x W 691mm

Insert size: 68.9" x 24" (1750mm x 609.5mm)

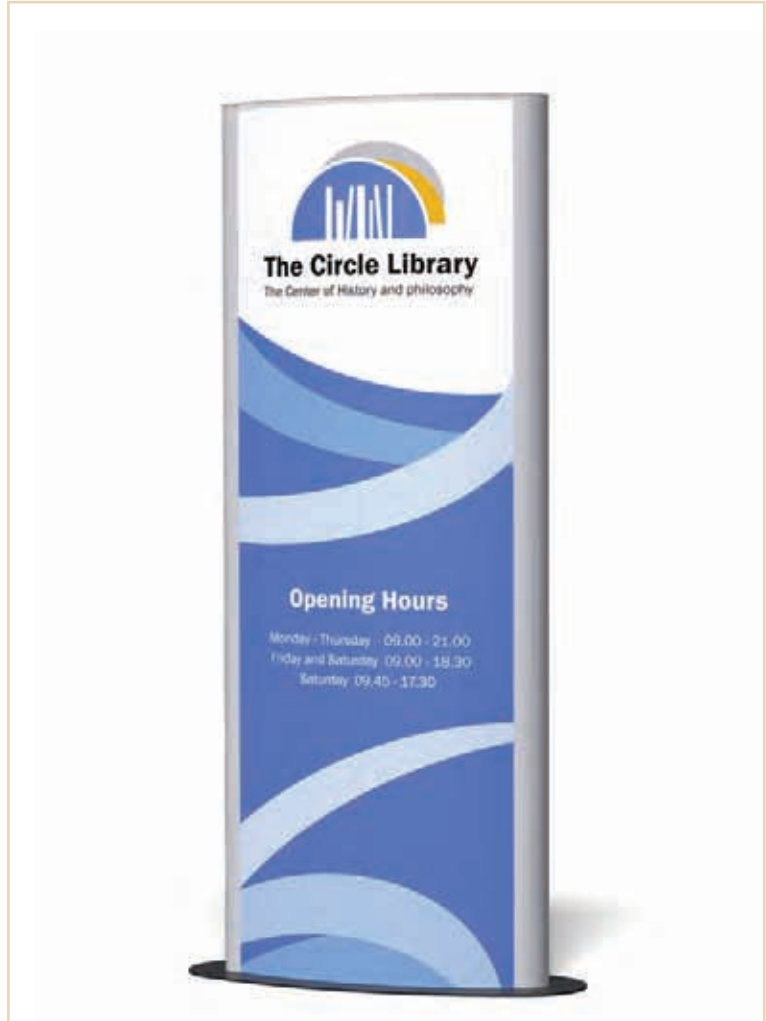

■ An illuminated pylon is ideal for displaying the operating hours and library map, especially when the library is closed and unlit or if the sign is located in places with less natural light. Updating is quick and easy: just remove the printed insert and replace it with a new one. Braille inserts are supported.



Operating Hours

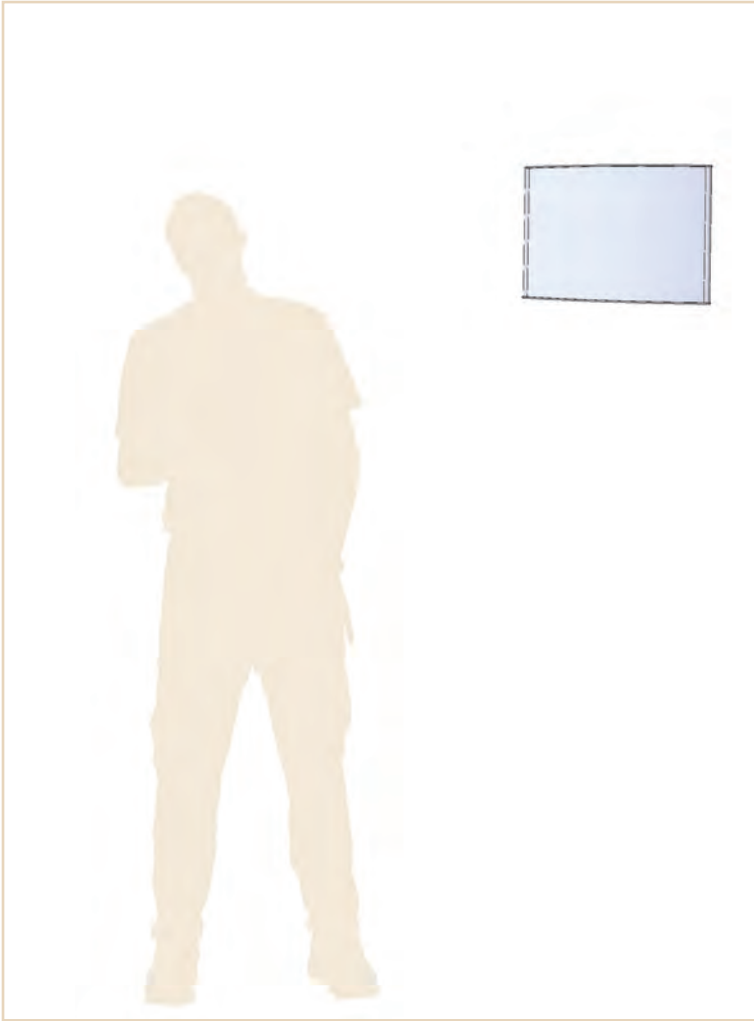

## Operating Hours

### SECT0036

Overall sign size: H 11.2" x W 7.87"  
H 284.5mm x W 200mm

Insert size: 10.94" x 7.64" (279mm x 194mm)

■ A wall mounted sign is ideal for displaying the operating hours of the library if a prominent wall is visible from the entrance. Updating is quick and easy: just remove the printed insert and replace it with a new one. Braille inserts are supported.



Floor Directory

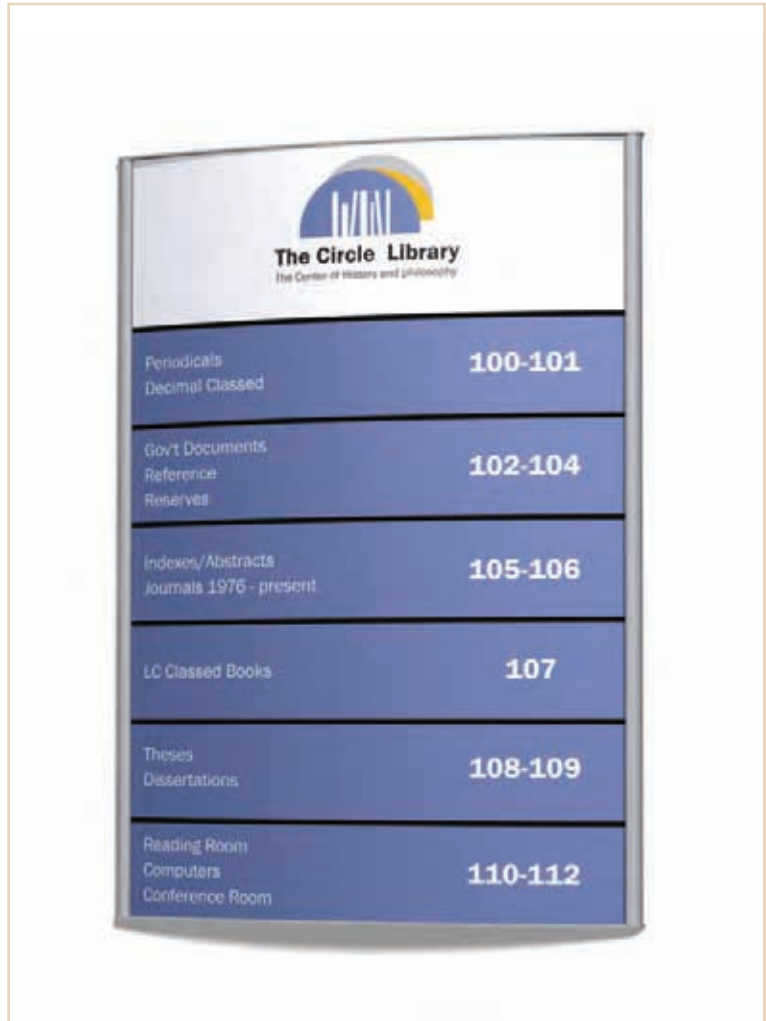

## Floor Directory

### D7

Overall sign size: H 22.44" x W 16"  
H 570mm x W 405mm

Insert size: 5" x 15.75" + 2.76" x 15.75"  
(127mm x 400mm + 70mm x 400mm)

■ A wall mounted directory sign is recommended for displaying the floor information at the entrance of each floor. The sign should be mounted on a wall visible from the entrance to each floor. Updating is quick and easy; just remove the printed insert and replace it with a new one. Braille inserts are supported.

Vista System sign offers a modular design, clear, precise and innovative, simple and functional.

## Departments' Entrance

Every library is divided into departments such as Arts, Music, Science and Literature. Each department must be clearly identified so visitors can easily and quickly find their destination. Vista System offers a wide selection of sign types for the departments' entrance.

Choose the right product for you and order today from your preferred Vista system sign dealer.





Department Title



**Department Title**

**SUS18**

Overall sign size: H 6.1" x W 22.84"  
H 154mm x W 580mm

Insert size: 5.82" x 22.83" (148mm x 580mm)



■ Suspended illuminated signs can be easily seen from a distance and, thus, are ideal for displaying the department title. Updating is quick and easy: just remove the printed insert and replace it with a new one. Braille inserts are supported.



Library department

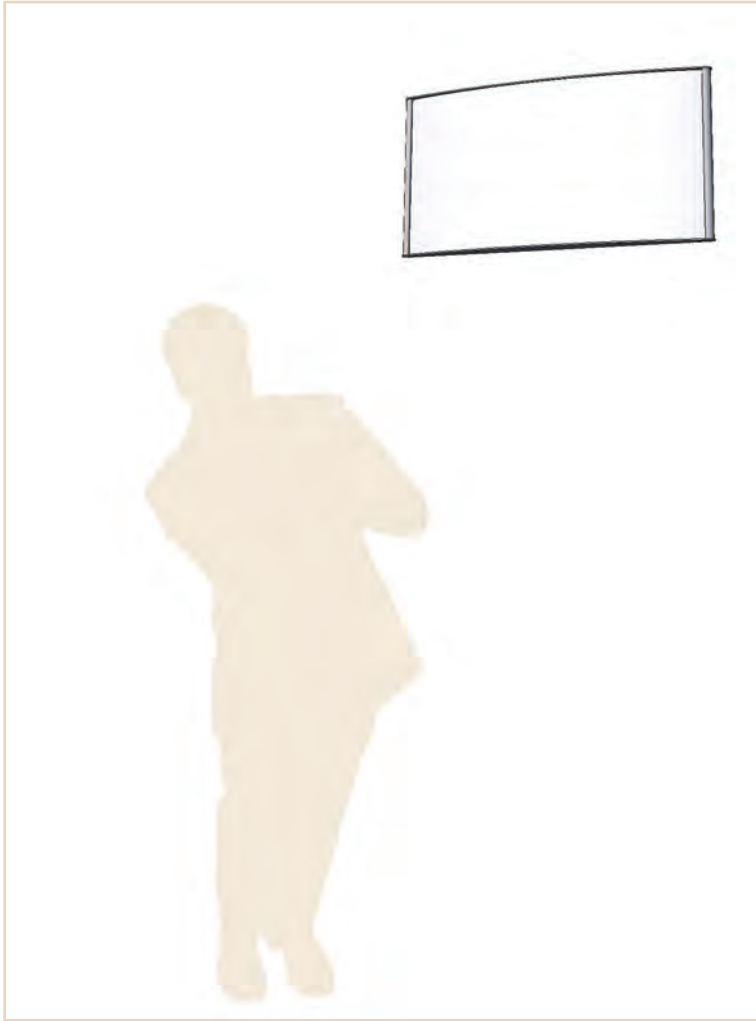

### Library department

#### WFP124

Overall sign size: H 9.85" x W 20"  
H 250mm x W 506.3mm

Insert size: 9.84" x 19.68" (250mm x 500mm)



■ A wall mounted sign is ideal for displaying the department title on a prominent wall visible from a distance. Updating is quick and easy, you just pop out the printed insert and replace it with a new one. Braille inserts are supported.

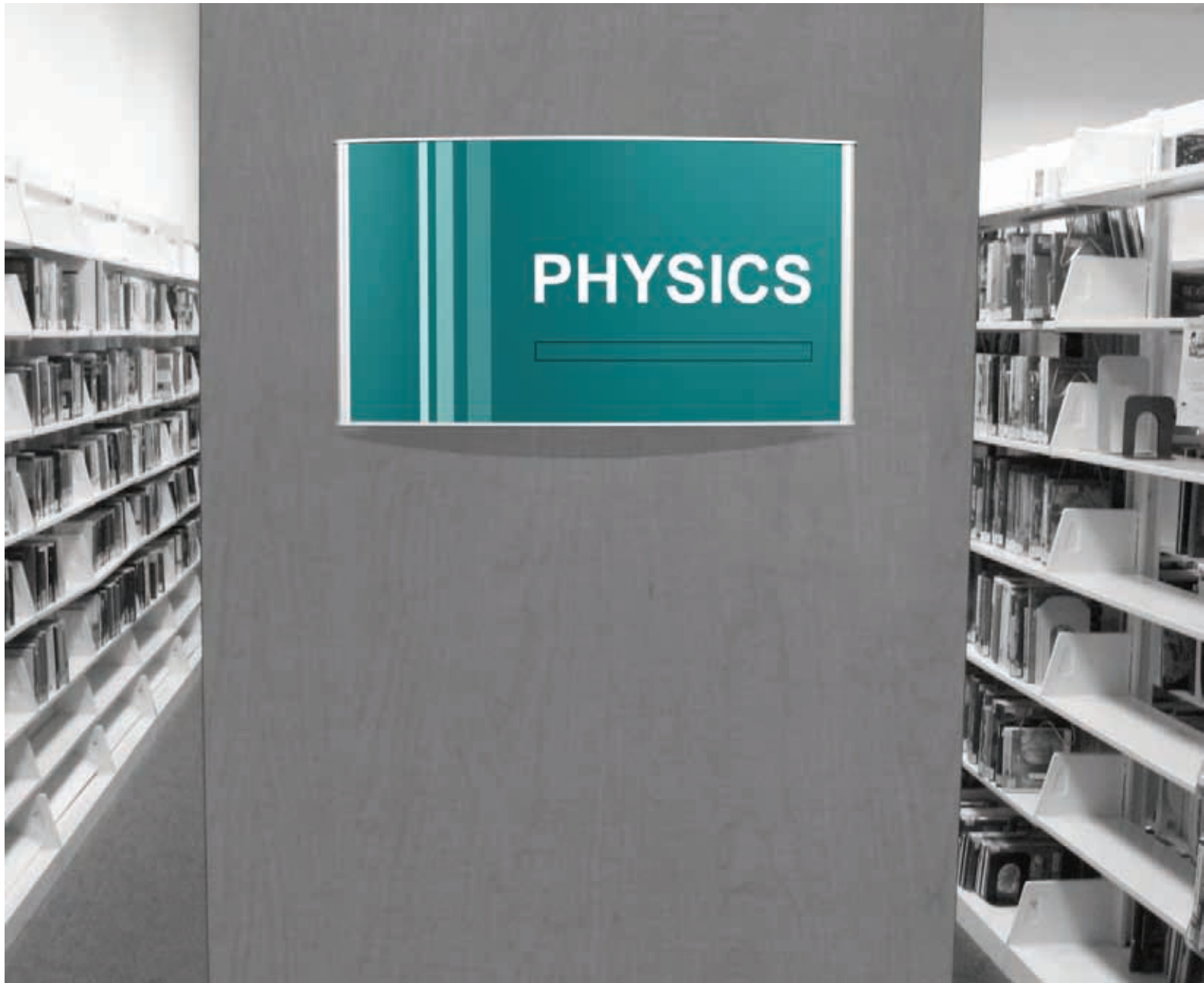

Library department (Braille)

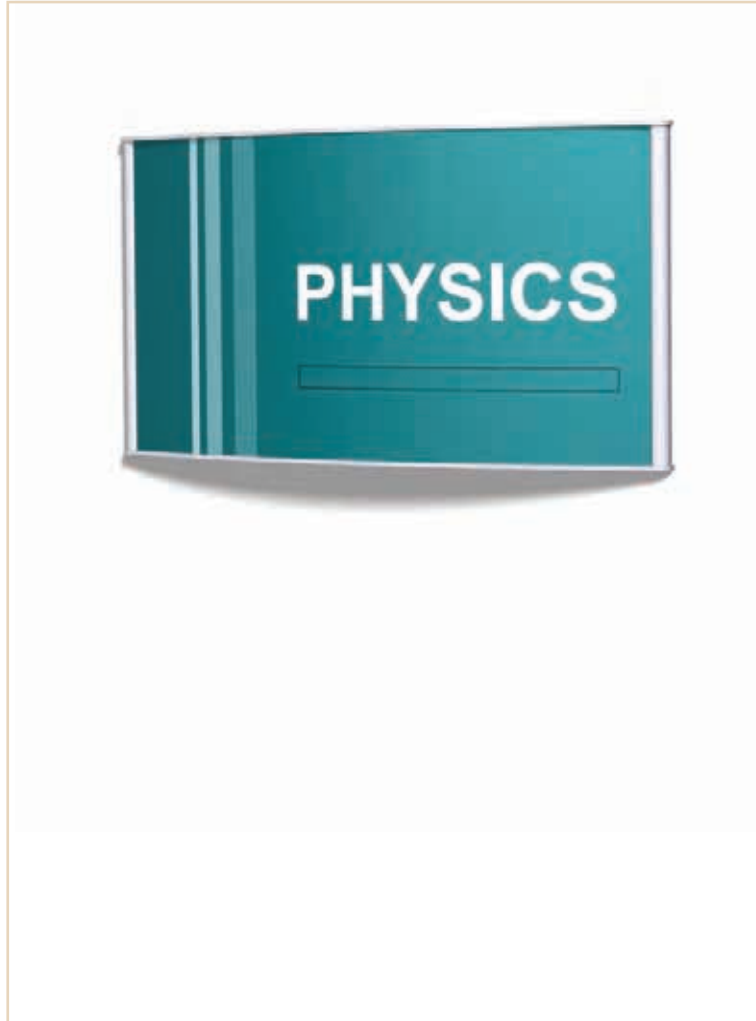
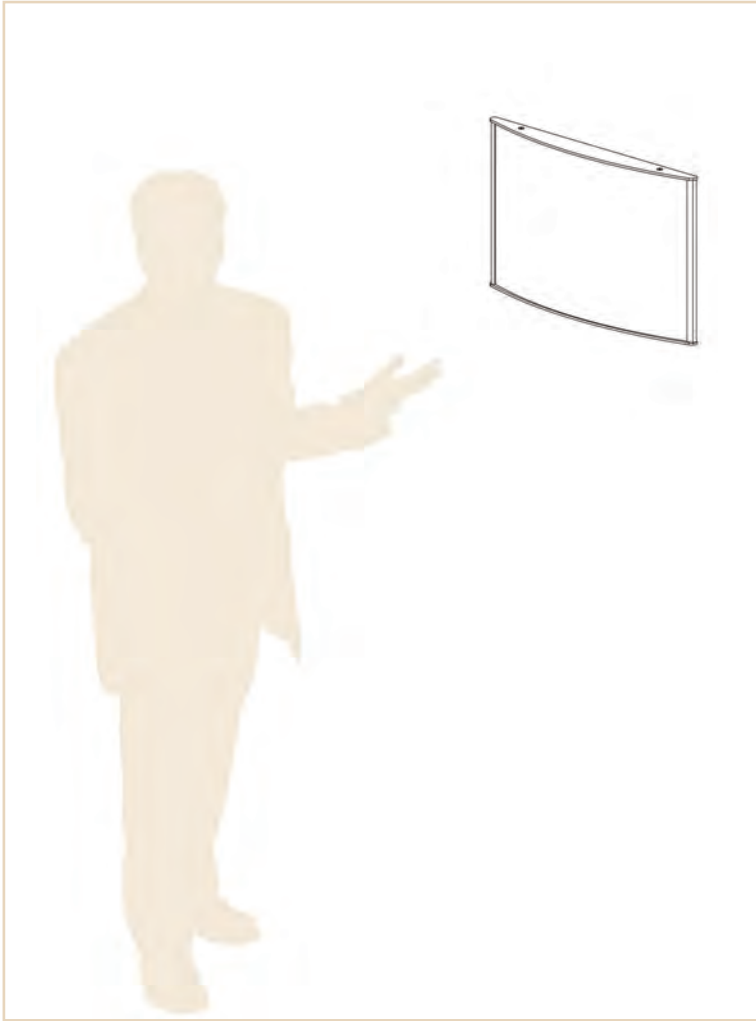

### Library department (Braille)

#### WFP158

Overall sign size: H 5.9" x W 11.2"  
H 150mm x W 284.6mm

Insert size: 5.9" x 10.98" (150mm x 279mm)

■ A wall mounted sign is ideal for displaying the department title on a prominent wall visible from a distance. Updating is quick and easy, you just pop out the printed insert and replace it with a new one. Braille inserts are supported.



Department Title

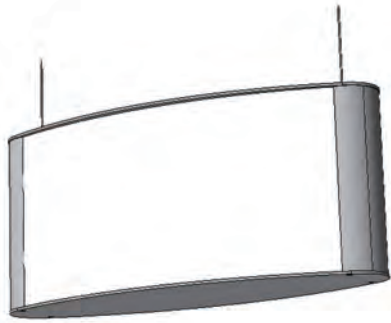

### Department Title

#### SECT0055

Overall sign size: H 7.87" x W 10.35"  
H 200mm x W 263mm

Insert size: 7.87" x 15.98" (200mm x 406mm)

■ Suspended illuminated signs can be easily seen from a distance and, thus, are ideal for displaying the department title. Updating is quick and easy: just remove the printed insert and replace it with a new one. Braille inserts are supported.



Library department

## Departments' Entrance

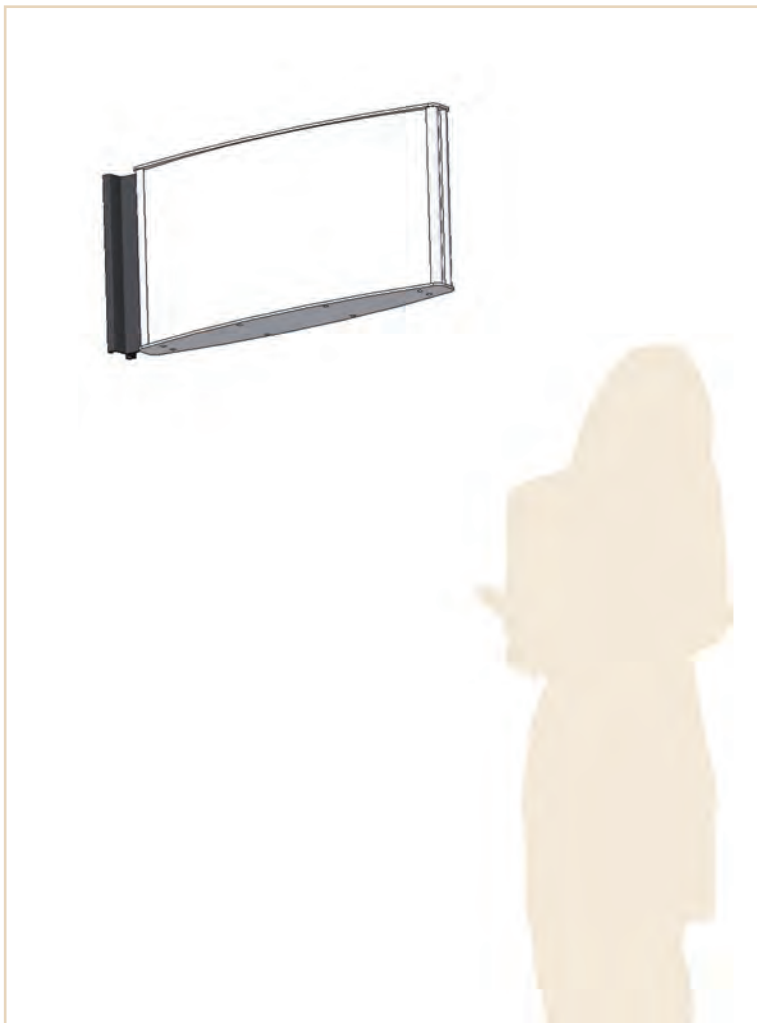

### Library department

#### SECT0054

Overall sign size: H 7.87" x W 17.5"

H 200mm x W 443mm

Insert size: 7.87" x 15.74" (200mm x 400mm)

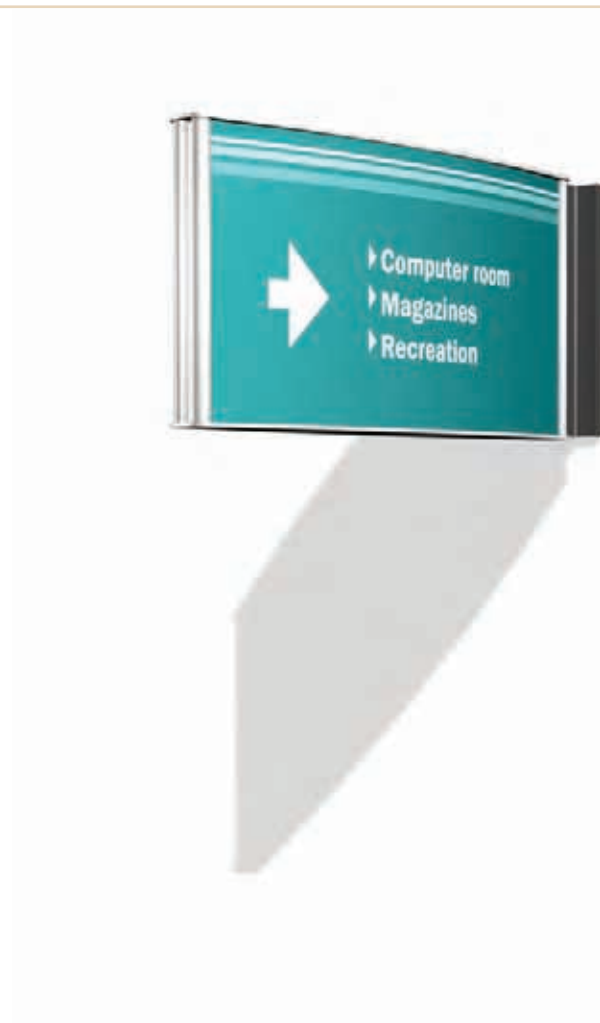

■ Projecting wall brackets (flag signs) are complementary signs that should be used along with the other types to display the department title. The benefit of the flag signs is that they give a needed extra visibility from viewing angles that are not covered by the other signs. Updating is quick and easy, you just pop out the printed insert and replace it with a new one. Braille inserts are supported.

Easy to read clear signs, that can be positioned to give maximum Information.

## Book Stands

In every library you must have book stands to display selected books from each department. Vista System offers three types of book stands: large pylons for displaying many books in a central location; post pylons for displaying a single book; and table stands for displaying books on selected tables. All stands feature an easy updateable sign frame for displaying messages and graphics along with the books.

Choose the right product for you and order today from your preferred Vista system sign dealer.





Rhombus Book Stand

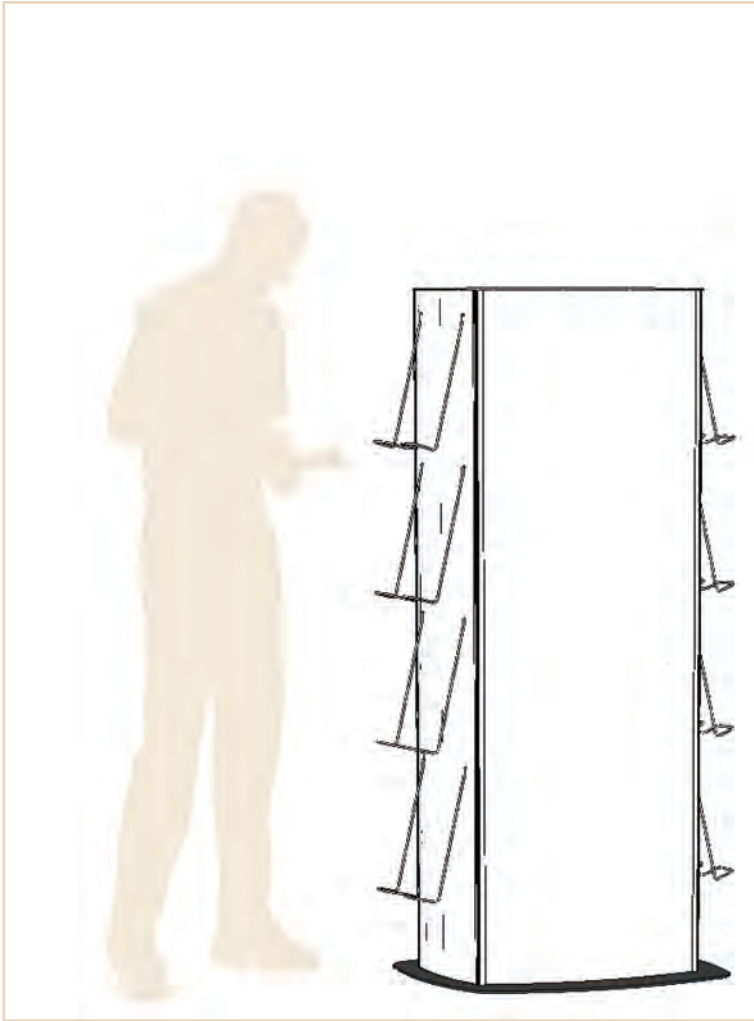

### Rhombus Book Stand

#### SECT0009

Overall sign size: H 60.35" x L 24" x W 11"  
H 1533mm x L 608.7mm x W 280.9mm

Insert size: 60" x 19.69" + 60" x 11"  
(1524mm x 500mm + 1524mm x 279.4mm)



■ The rhombus book stand is big and prominent. This book stand is impossible to miss! Use it for displaying a big selection of books in a central location of the library. Updating the printed area of the stand is quick and easy; just remove the printed insert and replace it with a new one. Braille inserts are supported.



Double Sided Book Stand

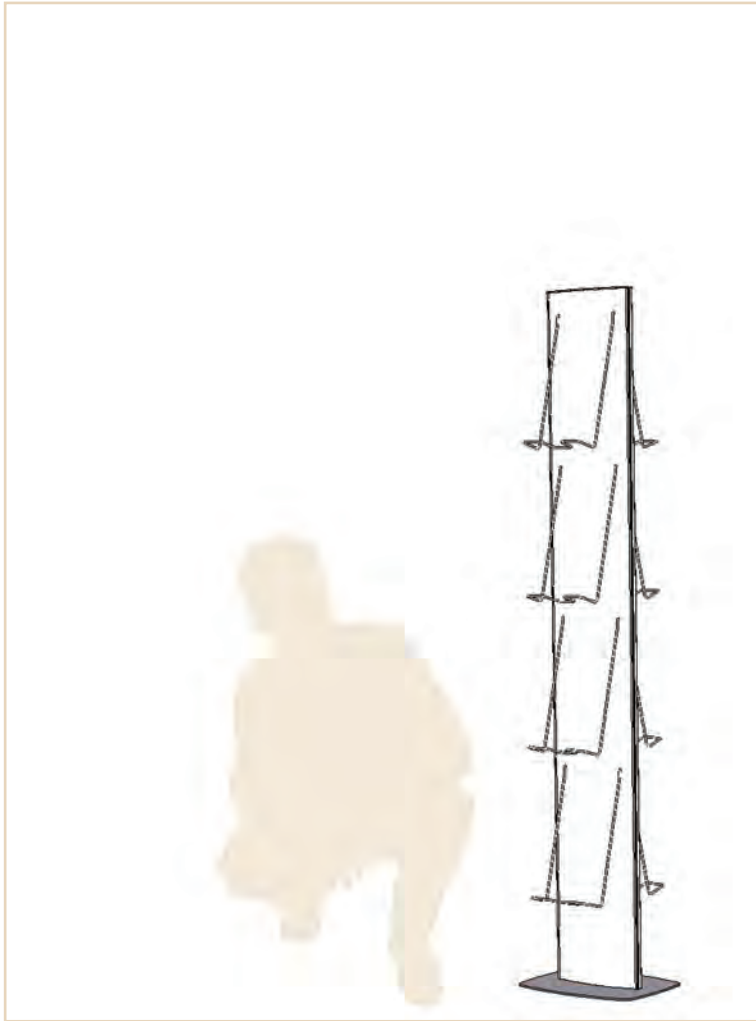

### Double Sided Book Stand

#### SECT0010

Overall sign size: H 60.3" x W 8.83"  
H 1530.5mm x W 224 mm

Insert size: 60" x 11" (1524mm x 279.4mm)



■ The double sided book stand features a lot of book slots, yet is very compact. Use it for displaying a big selection of books in a central location of the library or in less spacious locations. Updating the printed area of the stand is quick and easy: just remove the printed insert and replace it with a new one. Braille inserts are supported.



Book of the Month

## Book Stands

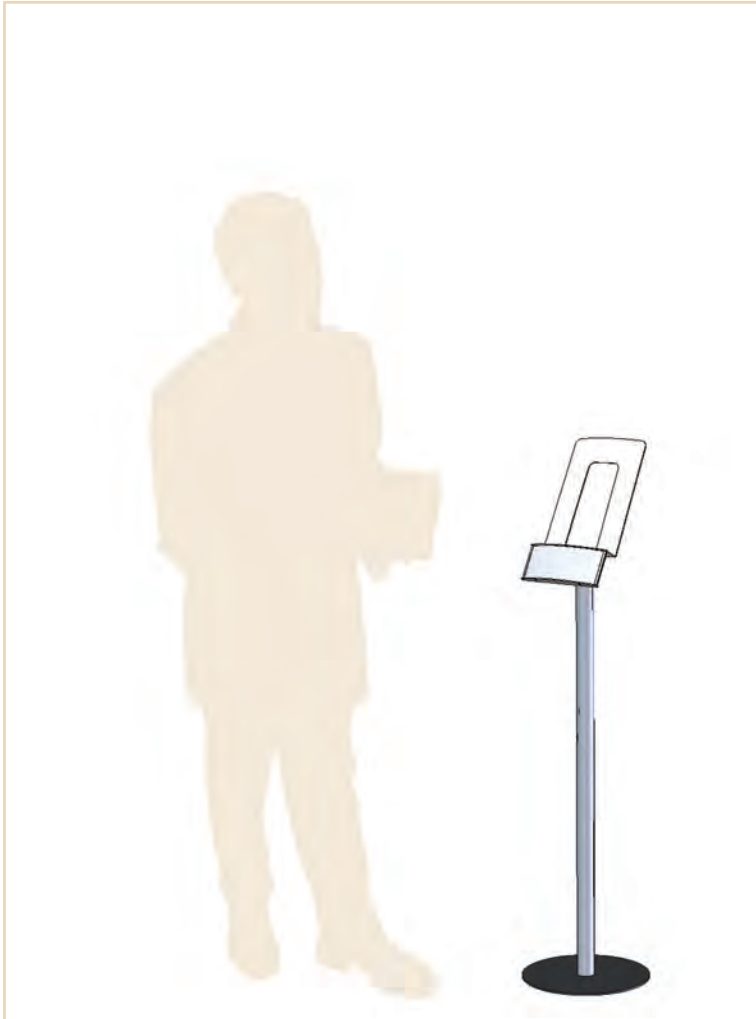

### Book of the Month

#### SECT0004

Overall sign size: H 50" x W 8.8"  
H 1262mm x W 224mm

Insert size: 8.54" x 3.15" (217mm x 80mm)

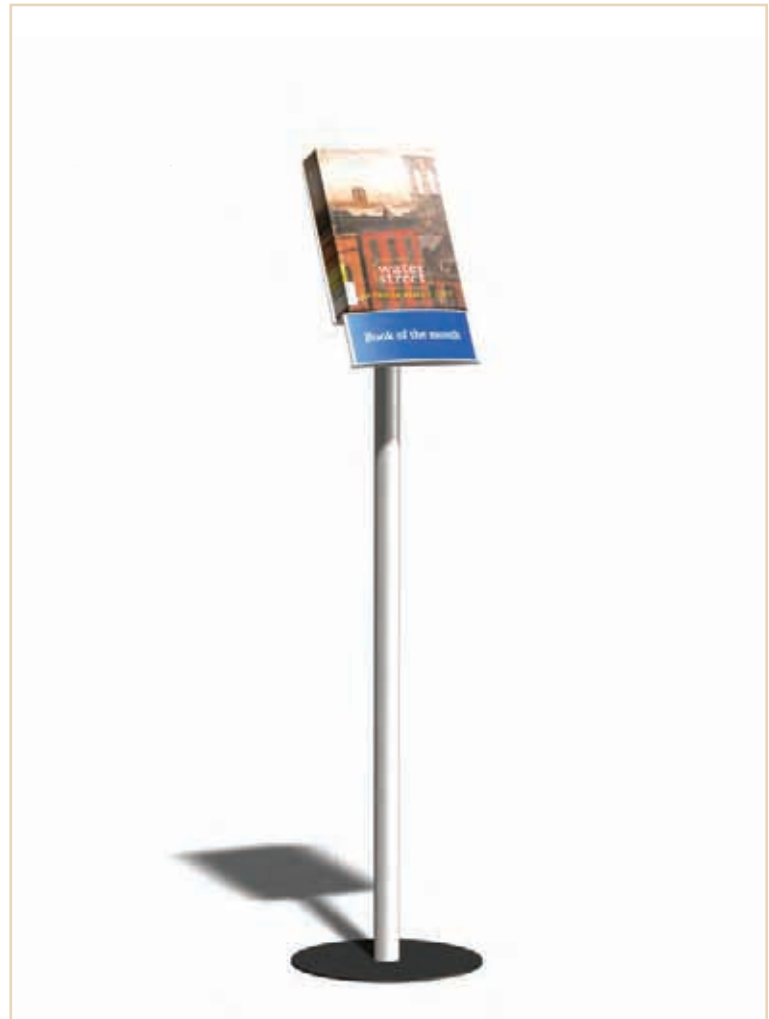

■ Use this stand to display the book of the month for each department. The label frame can be easily updated: just remove the printed insert and replace it with a new one. Braille inserts are supported.



Author of the Month



## Author of the Month

### SECT0005

Overall sign size: H 15.4" x W 9.4"  
 H 391.5mm x W 238.5mm

Insert size: 5.9" x 8.5" (150mm x 215.9mm)

■ This table stand features a larger than usual sign frame for displaying information about the author of the month. Updating is quick and easy: just remove the printed insert and replace it with a new one. Braille inserts are supported.



Scorpion Book of the Month

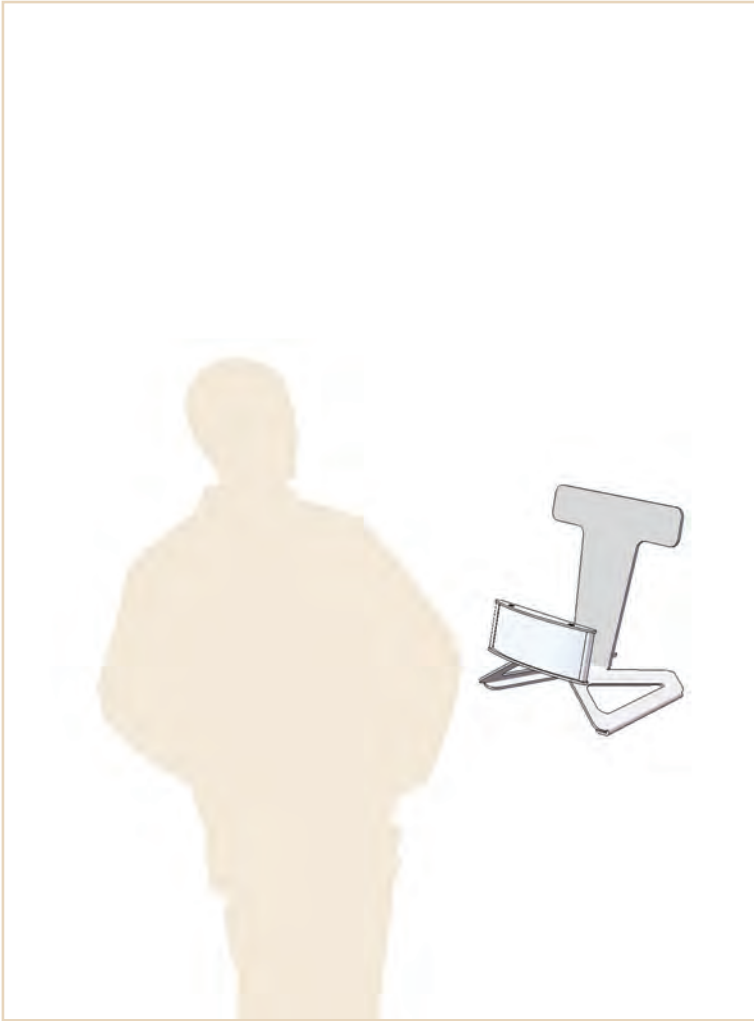

**Scorpion Book of the Month**

**SECT0006**

Overall sign size: H 8.5" x W 7.85"  
 H 216.7mm x W 199.5mm

Insert size: 1.96" x 5.82" (50mm x 148mm)

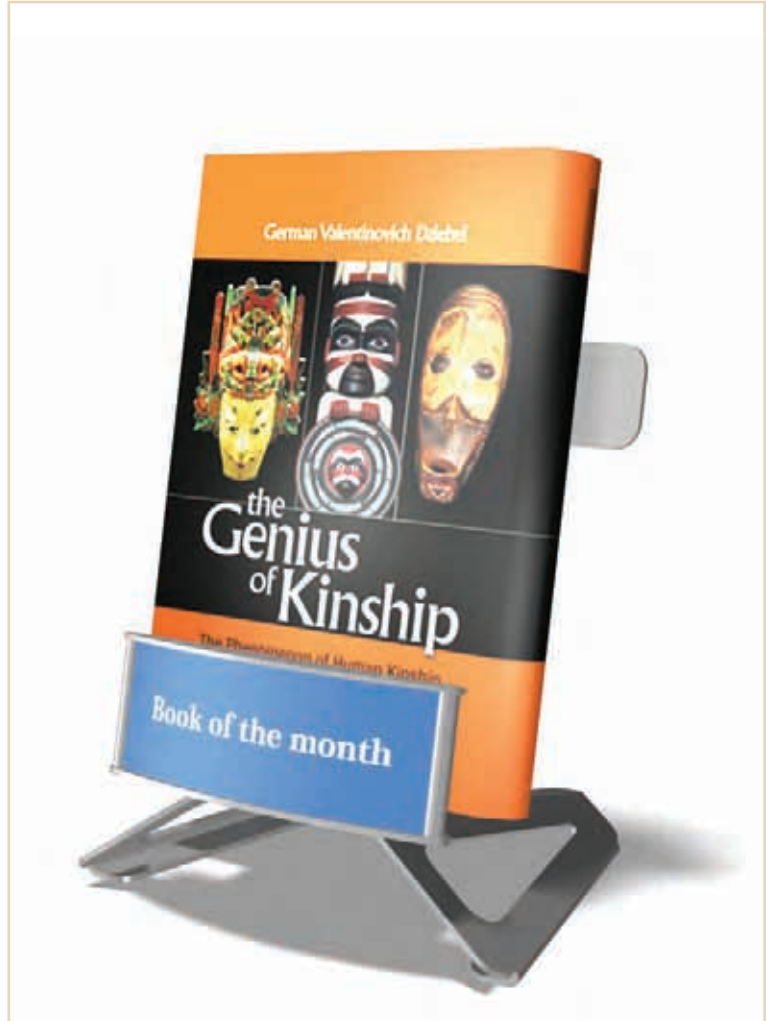

■ This elegant table stand is ideal for displaying the book of the month and features a small sign frame for displaying book details. Updating is quick and easy; just remove the printed insert and replace it with a new one. Braille inserts are supported.

The signs blend into the architectural design, while giving information that is simple to understand.

## Shelf Dividers

Vista System's shelf dividers are smart. They feature a small sign frame for displaying information about the area being divided. The dividers are ideal for instances when you need to divide a long shelf into separate thematic areas. Updating is quick and easy; just remove the printed insert and replace it with a new one.

Braille inserts are supported.





Books holder

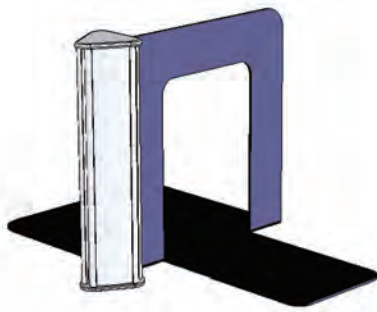

### Books holder

#### SECT0012

Overall sign size: H 9.8" x W 5.9"  
H 248mm x W 150mm

Insert size: 5.9" x 1.02" (150mm x 26mm)

■ Vista System's dividers for shelves are smart, they feature a small sign frame for displaying information about the area being divided. The dividers are ideal for occasions when you need to divide a long shelf into separate thematic areas. Updating is quick and easy; you just pop out the printed insert and replace it with a new one. Braille inserts are supported.

With Vista System, you get what is expected from a leading international sign manufacturer.

# Dewey Decimal System

Every library uses a classification system for easily accessing its books. The classification codes should be clearly displayed throughout the library in key locations like the main halls, department entries, and book shelves. Vista System offers a variety of sign frames for this purpose.

Choose the right product for you and order today from your preferred Vista System sign dealer.



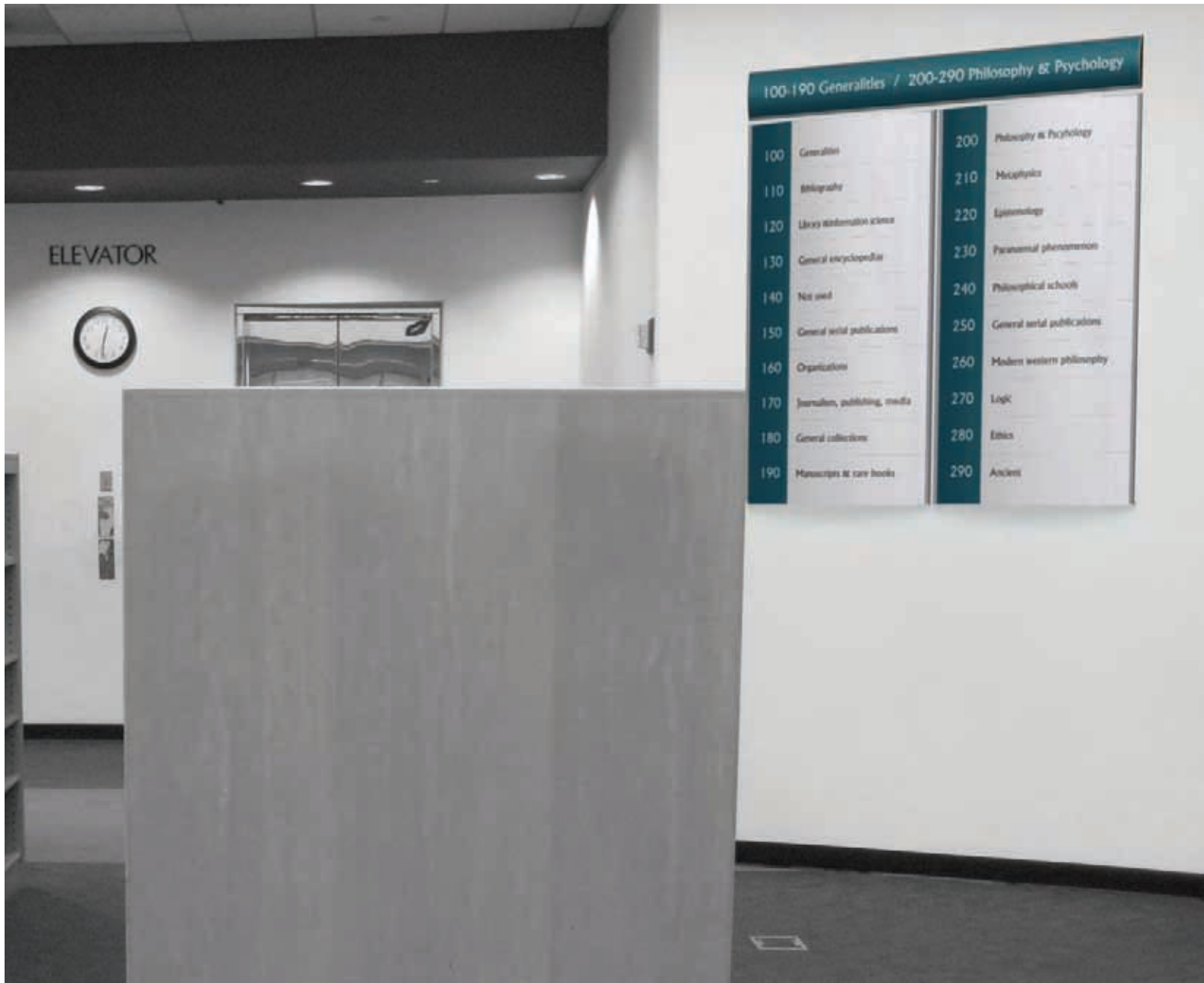

Directory Categories Index

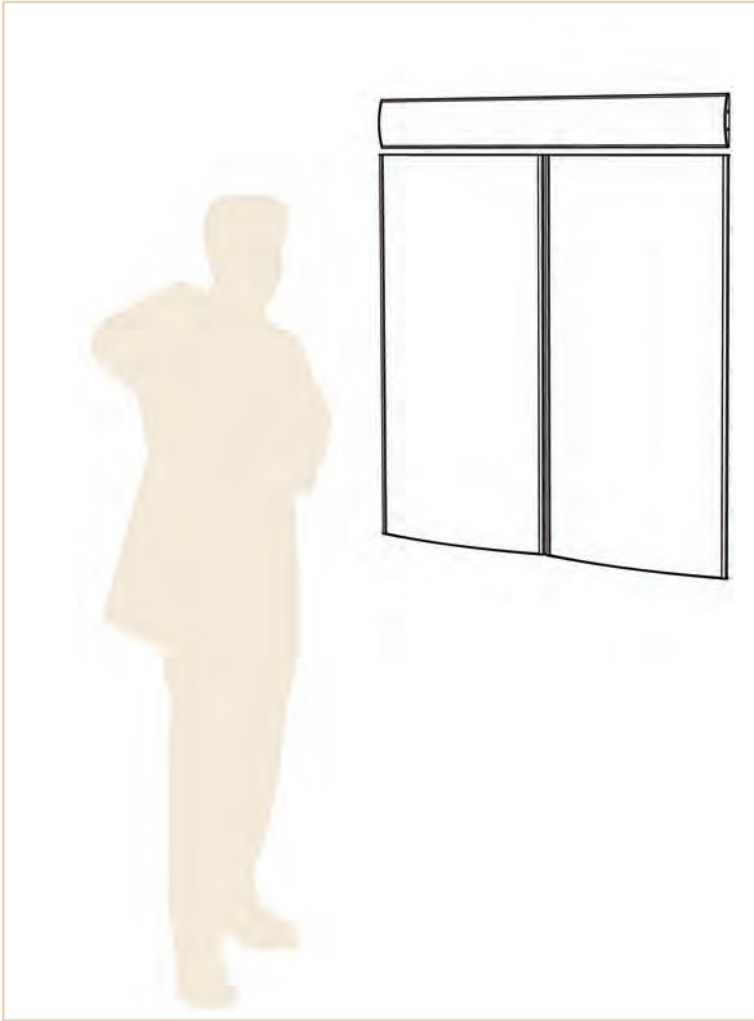

## Directory Categories Index

### SECT0047

Overall sign size: H 6.02" x W 39.37" + H 37.4" x W 19.9" (x2)  
 H 153mm x W 1000mm + H 950mm x W 506.3mm (x2)

Insert size: 4.56" x 39.37" (116mm x 1000mm) +  
 37.4" x 19.68" (950mm x 500mm) (x2)

100-190 Generalities / 200-290 Philosophy & Psychology			
100	Generalities	200	Philosophy & Psychology
110	Bibliography	210	Metaphysics
120	Library & information science	220	Epistemology
130	General encyclopedias	230	Paranormal phenomena
140	Not used	240	Philosophical schools
150	General serial publications	250	General serial publications
160	Organizations	260	Modern western philosophy
170	Journalism, publishing, media	270	Logic
180	General collections	280	Ethics
190	Manuscripts & rare books	290	Ancient

■ The directory categories index is ideal for displaying main category trees at key locations throughout the library. It can be mounted to any flat surface. Updating each of the directory's frames is quick and easy; just remove the printed insert and replace it with a new one. Braille inserts are supported.



Portrait Category Entry

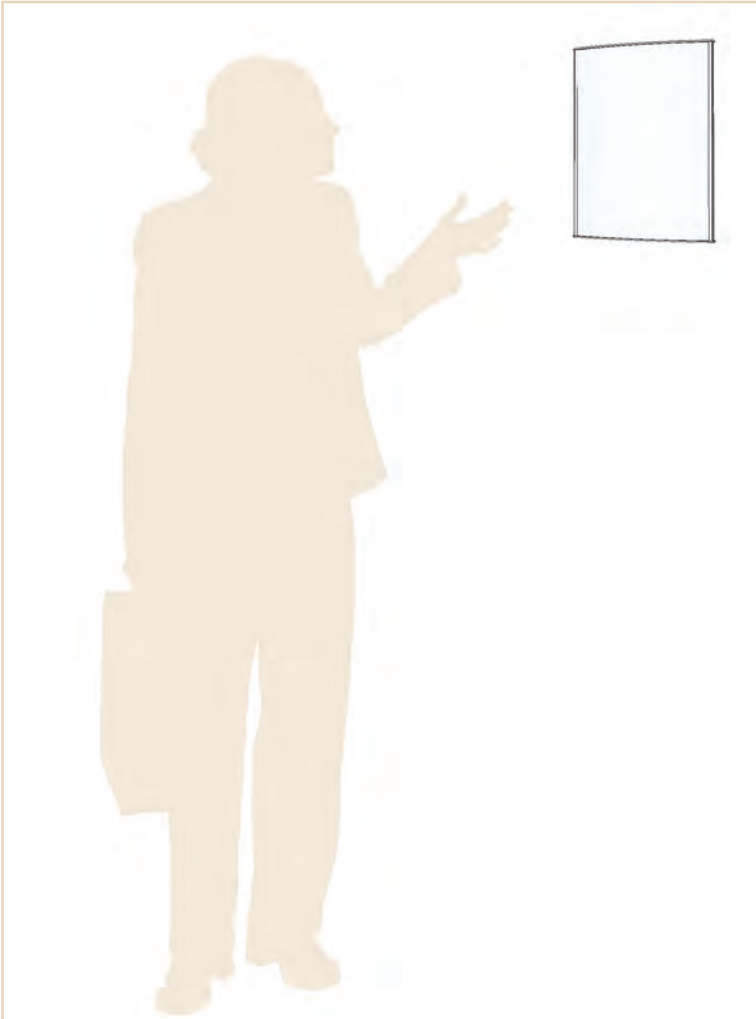

### Portrait Category Entry

#### WFP84

Overall sign size: H 11" x W 8.83"  
H 279.4mm x W 224mm

Insert size: 11" x 8.54" (279.4mm x 217mm)

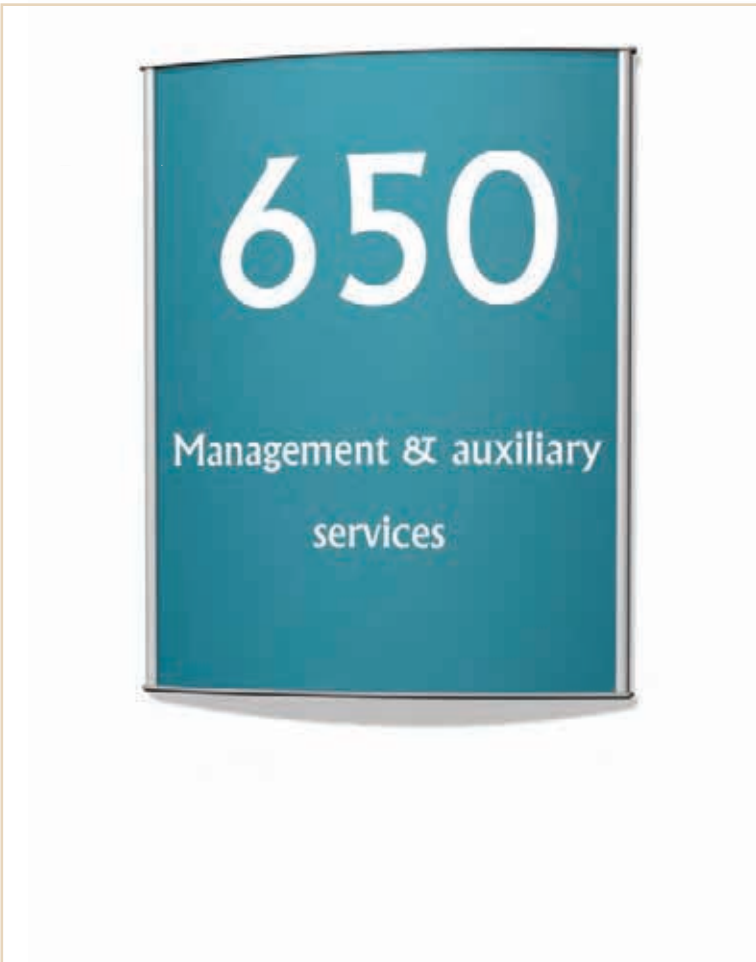

■ The portrait category entry is ideal for displaying specific categories at key locations throughout the library. It is designed to display a portrait oriented insert and can be mounted to any flat surface. Updating is quick and easy: just remove the printed insert and replace it with a new one. Braille inserts are supported.



Landscape Category Entry

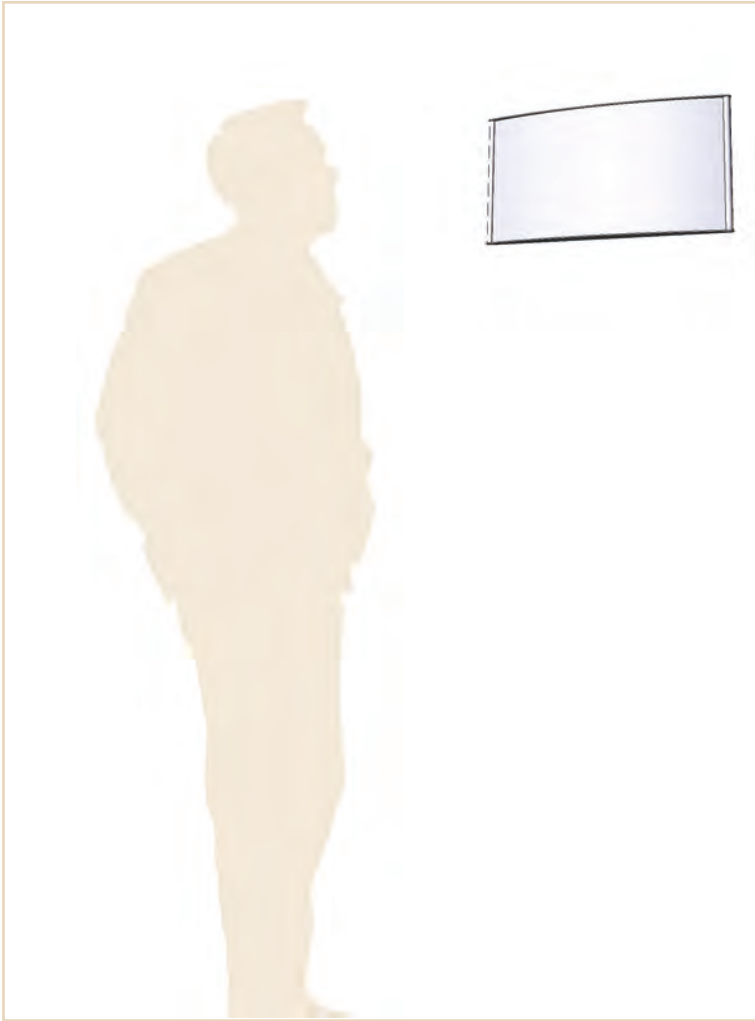

### Landscape Category Entry

#### SECT0048

Overall sign size: H 9.84" x W 19.9"  
H 250mm x W 506.3mm

Insert size: 9.84" x 19.68" (250mm x 500mm)

■ The landscape category entry is ideal for displaying specific categories at key locations throughout the library. It is designed to display a landscape oriented insert and can be mounted to any flat surface. Updating is quick and easy; just remove the printed insert and replace it with a new one. Braille inserts are supported.



Shelf Indicator

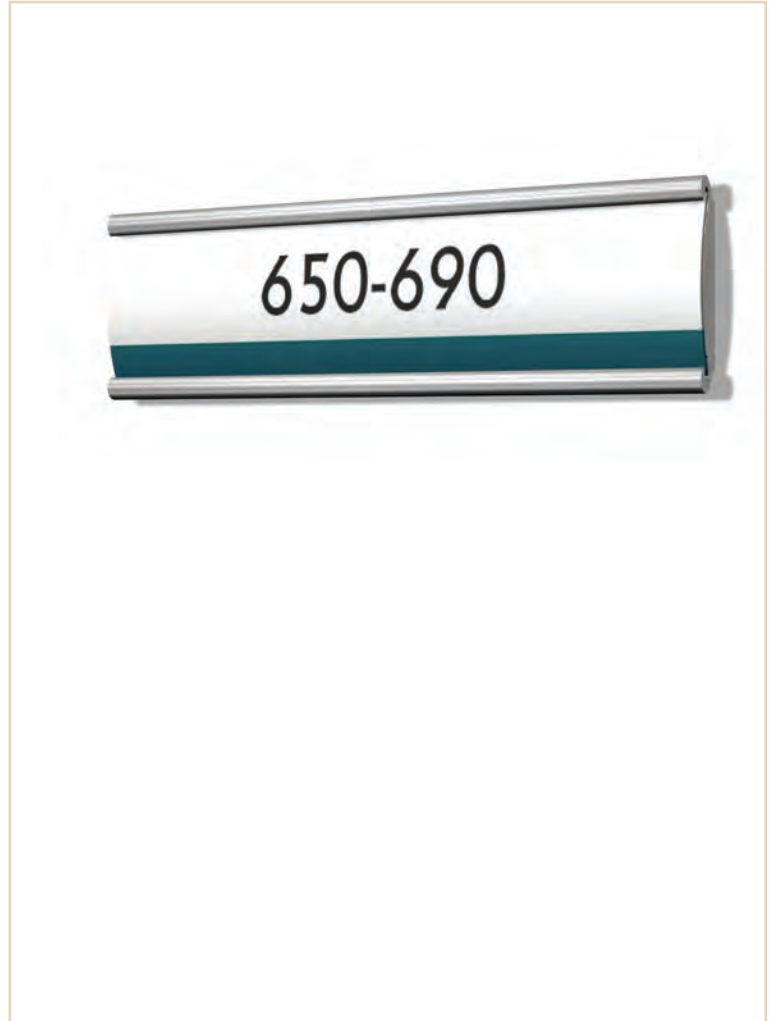
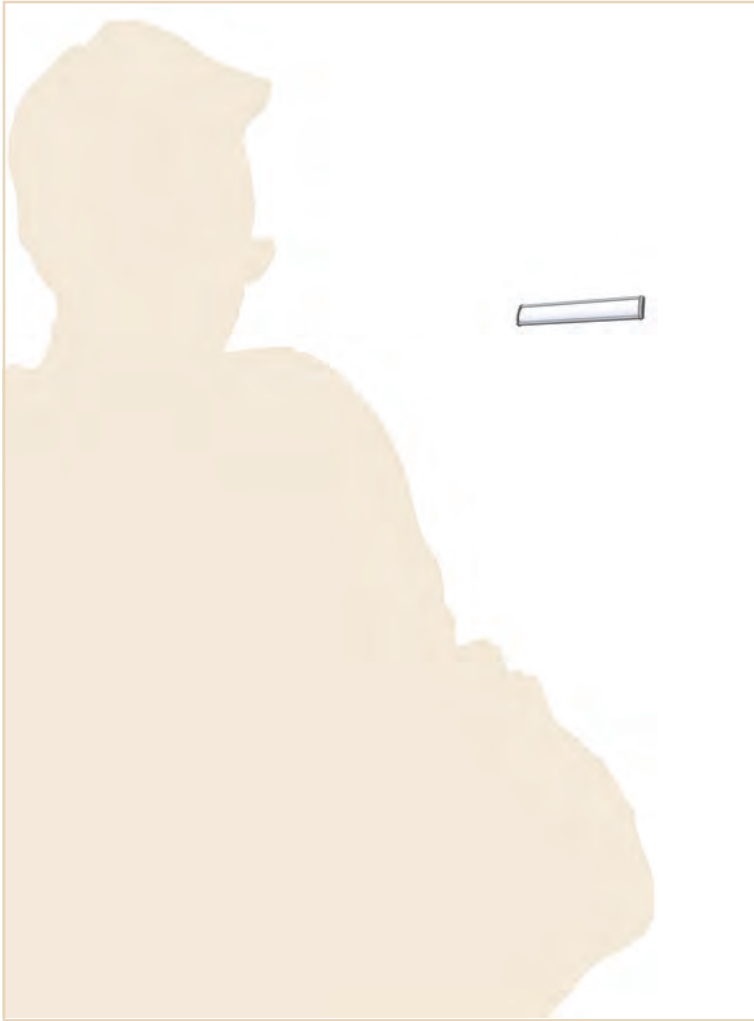

### Shelf Indicator

#### WFL62

Overall sign size: H 0.71" x W 2.36"  
H 18mm x W 60mm

Insert size: 1.02" x 5.9" (26mm x 150mm)

■ The shelf indicator is designed for displaying specific categories on the shelves of the library. Updating is quick and easy: just remove the printed insert and replace it with a new one. Braille inserts are supported.

All Vista System signs accept Braille and tactile inserts.  
No need for a separate system for the disabled.

## Librarian Position

The librarian position is a central location of the library, people come here for information, borrowing or returning books, payment and feedback. This central location is an ideal place for displaying the library's fees and community messages.

Choose the right product for you and order today from your preferred Vista system sign dealer.



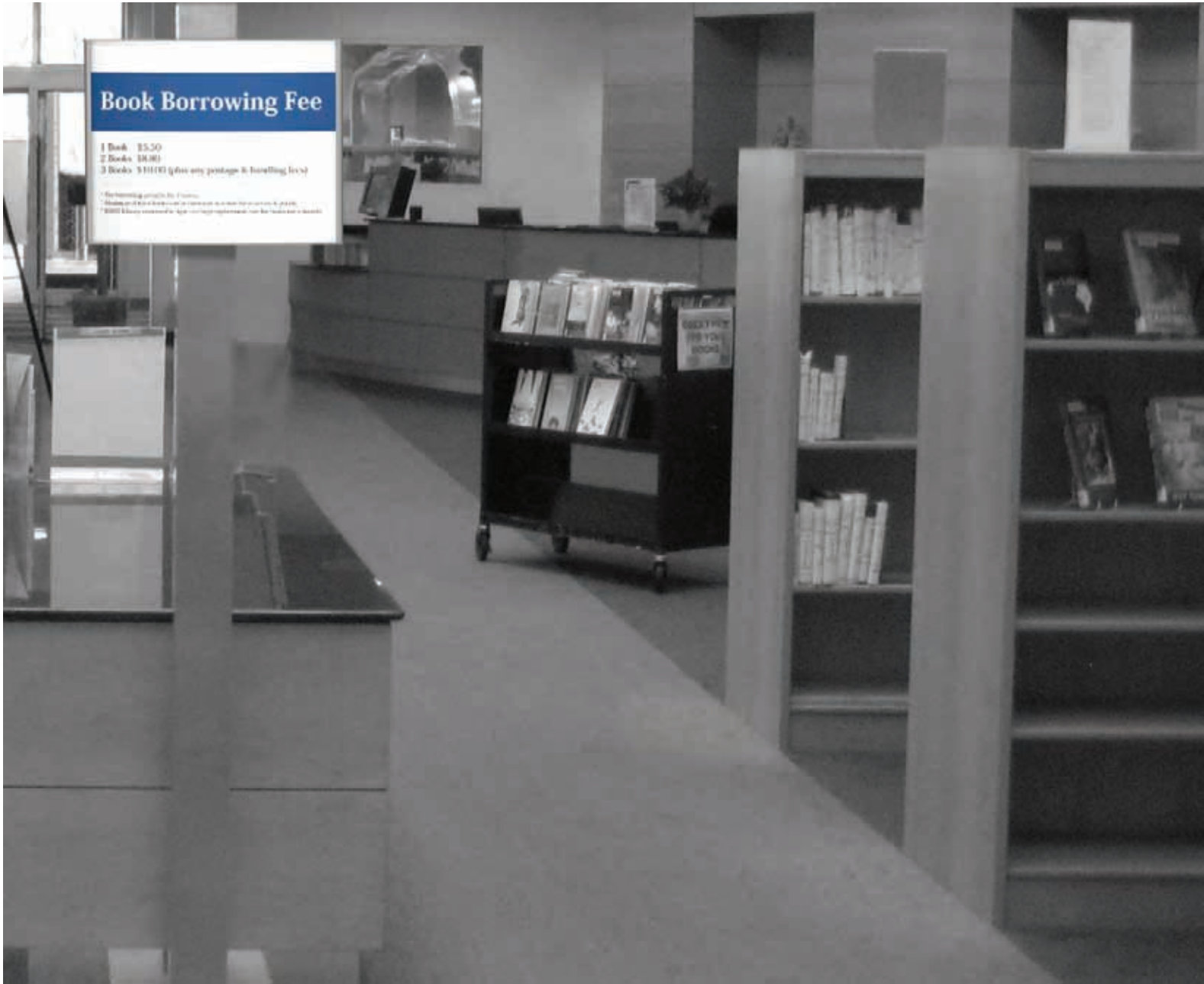

## Book Borrowing Fee

- 1 Book \$5.50
- 2 Books \$8.00
- 3 Books \$11.00 (plus any postage & handling fees)

\* Borrowing limits by Province  
\* Maximum of 200 books can be borrowed at a time for personal use only  
\* 2000 Library reserved for special projects/requirements from the Province or outside

Books borrowing fee

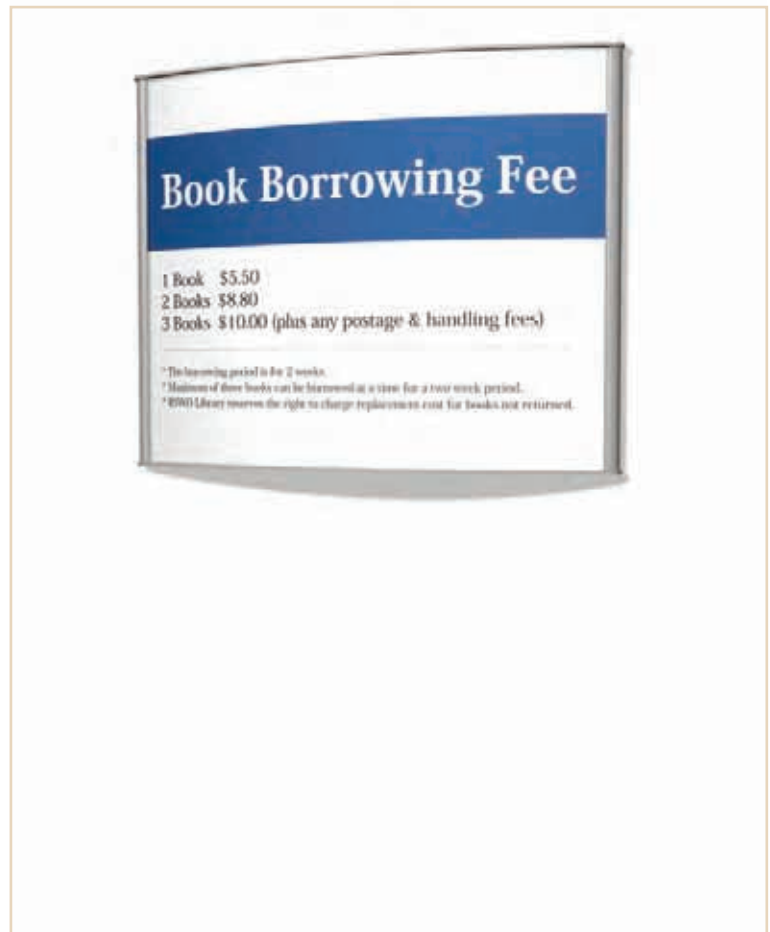
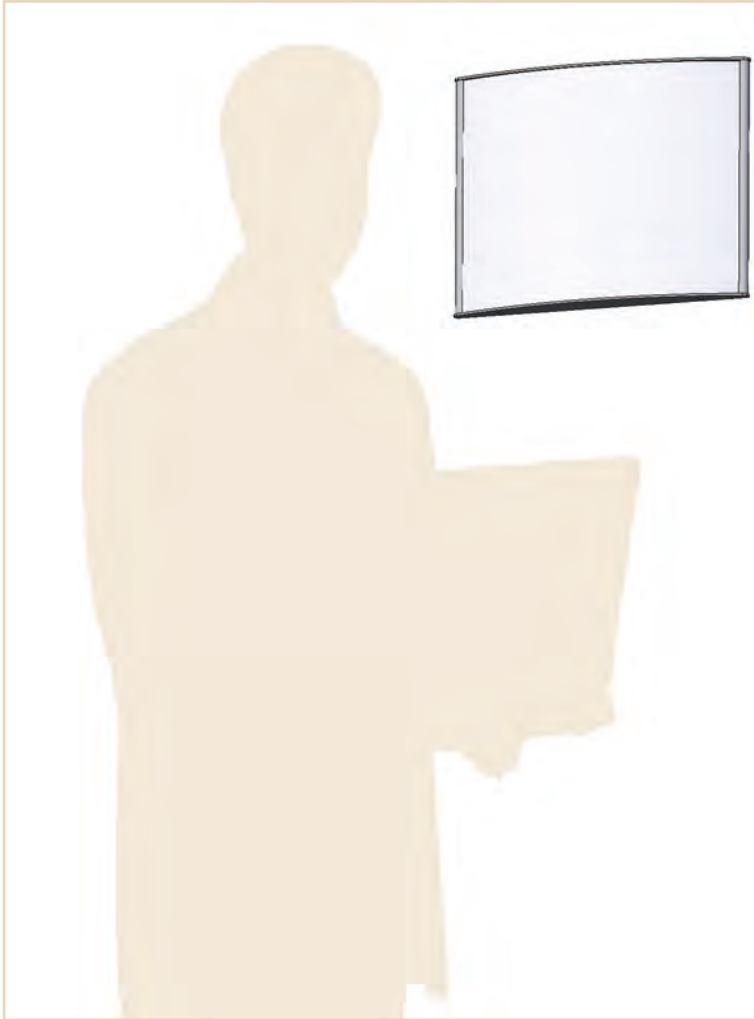

### Books borrowing fee

#### SECT0046

Overall sign size: H 8.66" x W 11.22"  
 H 220mm x W 285mm

Insert size: 8.66" x 11" (220mm x 279mm)

■ Wall frames are ideal for displaying the book borrowing fee chart. Wall frames are very flexible; they come in many sizes and types and can be easily mounted. Updating is quick and easy; you just pop out the printed insert and replace it with a new one.



Volunteers for the library

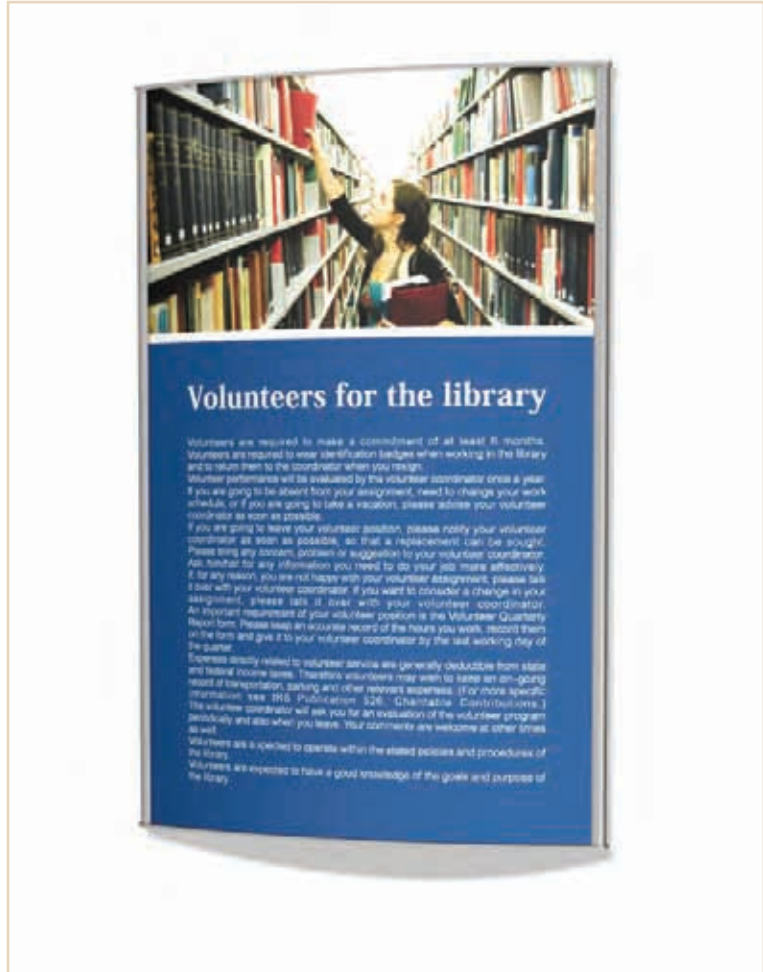
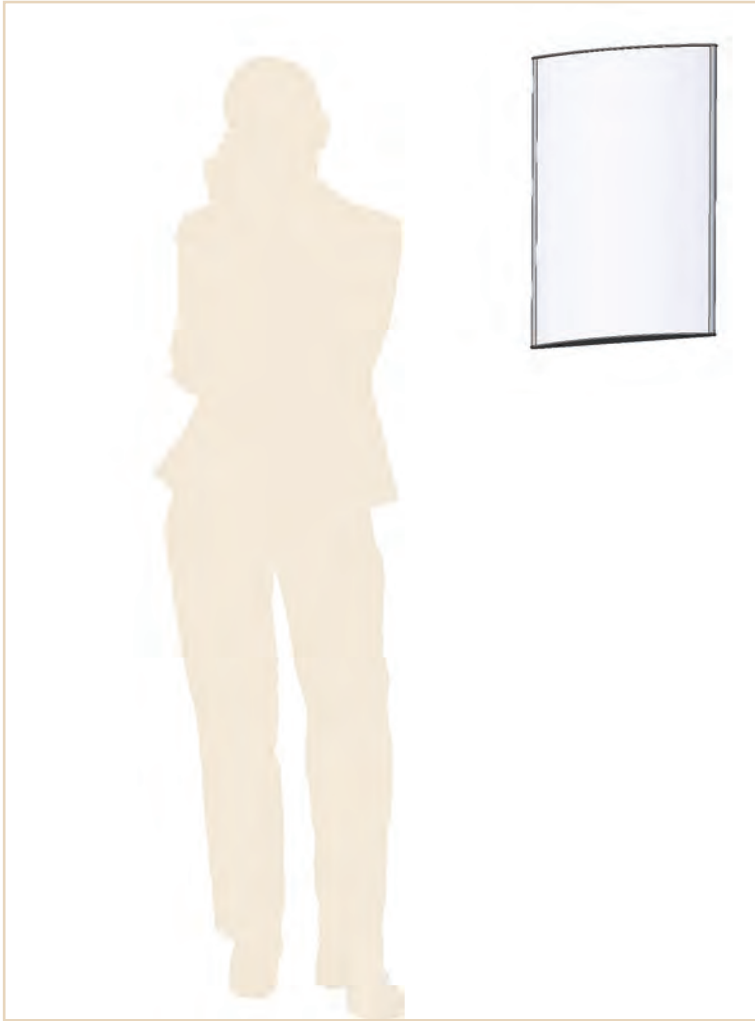

## Volunteers for the library

### WFP168

Overall sign size: H 17" x W 11.22"  
H 432mm x W 285mm

Insert size: 17" x 11" (432mm x 279mm)

■ Wall frames are ideal for displaying community messages on the wall behind the librarian. Wall frames are very flexible; they come in many sizes and types and can be easily mounted. Updating is quick and easy; you just pop out the printed insert and replace it with a new one.

Directional and Information signs are crucial in today's bustling health care facilities.

# Instructional Signs

Instructional signs are used to display library information such as where to put returned books.

Choose the right product for you and order today from your preferred Vista system sign dealer.





Please return books to cart

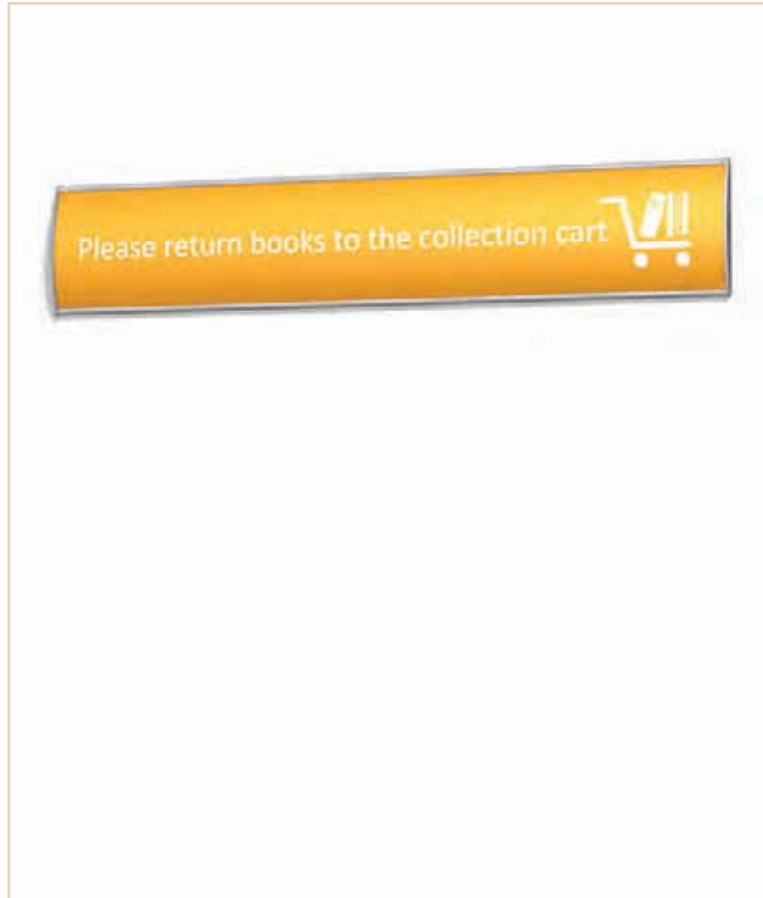
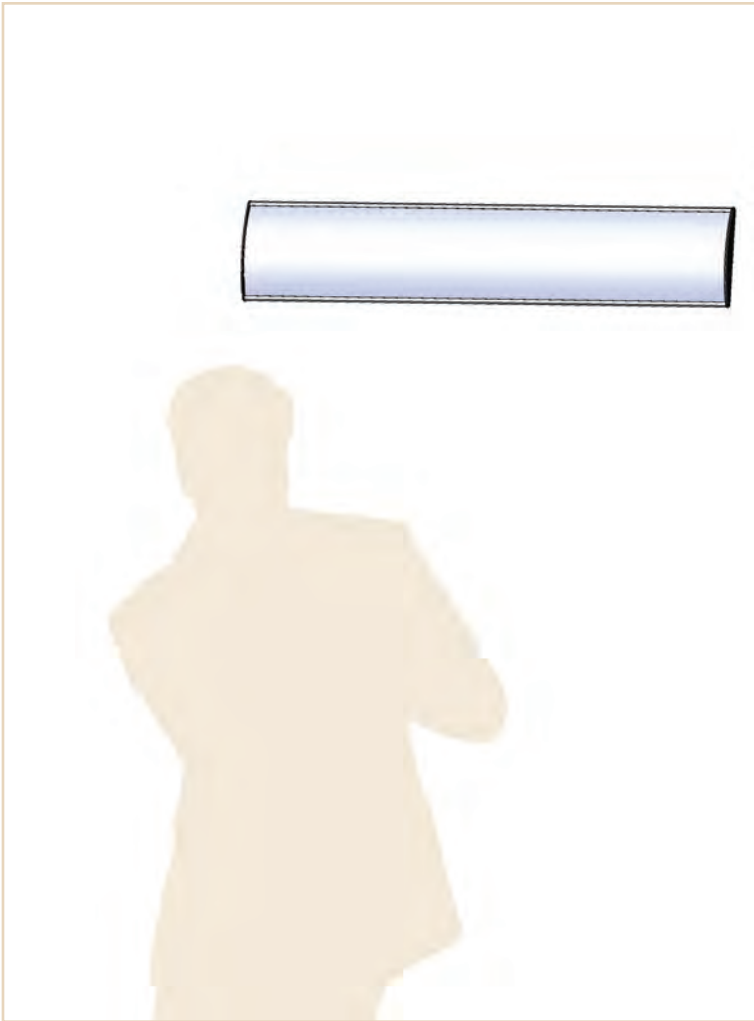

**Please return books to cart**

**SECT0042**

Overall sign size: H 4.84" x W 24.8"  
H 123mm x W 630mm

Insert size: 4.64" x 28.4" (118mm x 630mm)

■ Wall frames are ideal for displaying instructional messages around the library. Wall frames are very flexible; they come in many sizes and types and can be easily mounted. Updating is quick and easy; you just pop out the printed insert and replace it with a new one. Braille inserts are supported.



Paper only



**Paper only**

**SECT0003**

Overall sign size: H 6" x W 15.15"  
H 153mm x W 385mm

Insert size: 5.82" x 9.84" (148mm x 250mm)

■ Wall frames are ideal for displaying instructional messages around the library. Wall frames are very flexible; they come in many sizes and types and can be easily mounted. Updating is quick and easy; you just pop out the printed insert and replace it with a new one.

Availability of service through thousands of sign professionals worldwide.

# Wayfinding

Wayfinding signs are designed to direct visitors around the library's facilities. The most effective wayfinding signs for libraries are suspended signs which can be easily seen from a distance, wall signs which can be mounted on any flat surface, and flag signs which are perpendicular to the wall and give more visibility options.

Choose the right product for you and order today from your preferred Vista system sign dealer.





Coat Checking

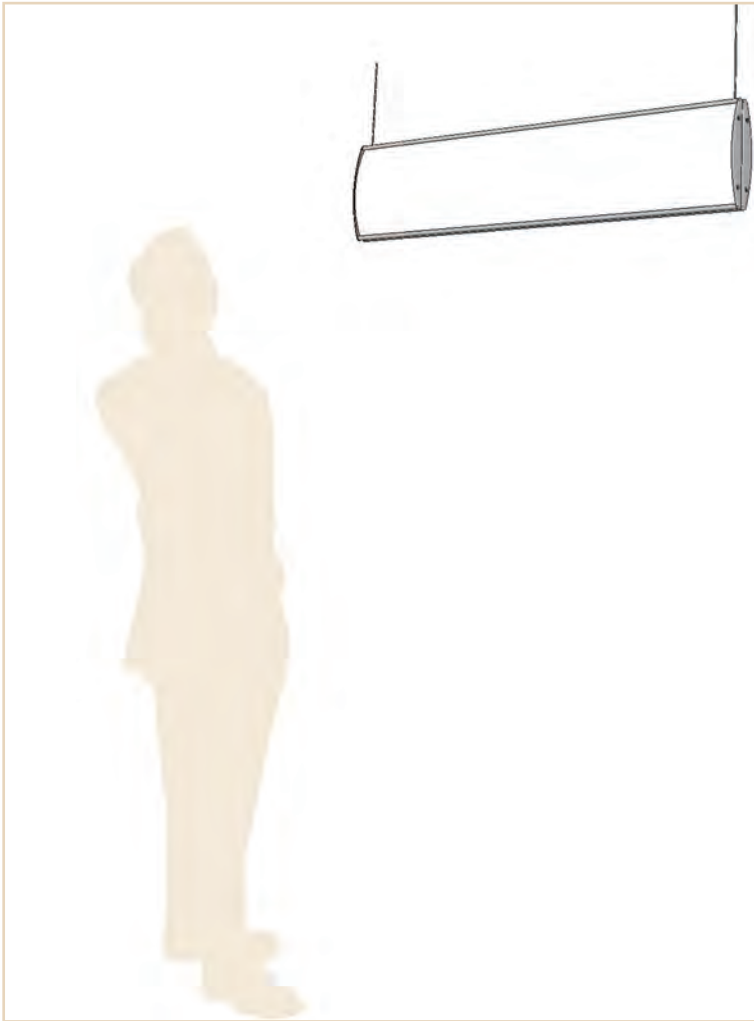

## Coat Checking

### SUS19

Overall sign size: H 6" x W 28.15"  
H 151mm x W 715mm

Insert size: 5.83" x 27.95" (148mm x 710mm)

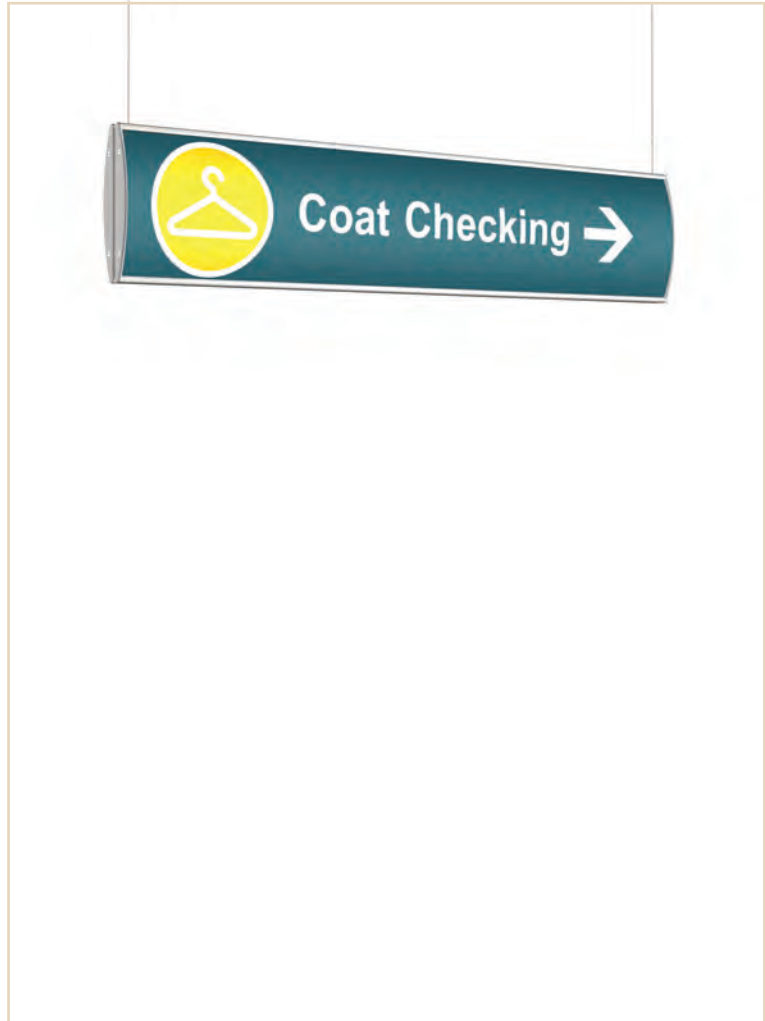

- Use a well placed suspended sign to direct visitors to the coat checking or luggage checking positions. Updating is quick and easy: just remove the printed insert and replace it with a new one. Braille inserts are supported.

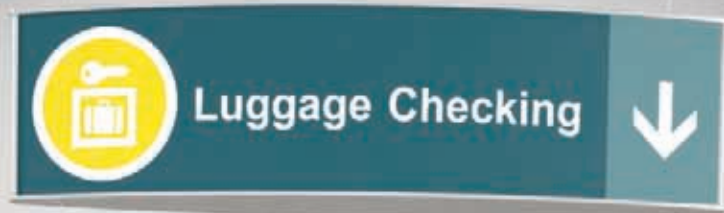

Luggage checking



## Luggage checking

### SECT0057

Overall sign size: H 6.22" x W 23.7"  
H 158mm x W 602mm

Insert size: 5.9" x 23.62" (150mm x 600mm)

■ Use a well placed suspended sign to direct visitors to the coat checking or luggage checking positions. Updating is quick and easy: just remove the printed insert and replace it with a new one. Braille inserts are supported.



Cafeteria Pictogram

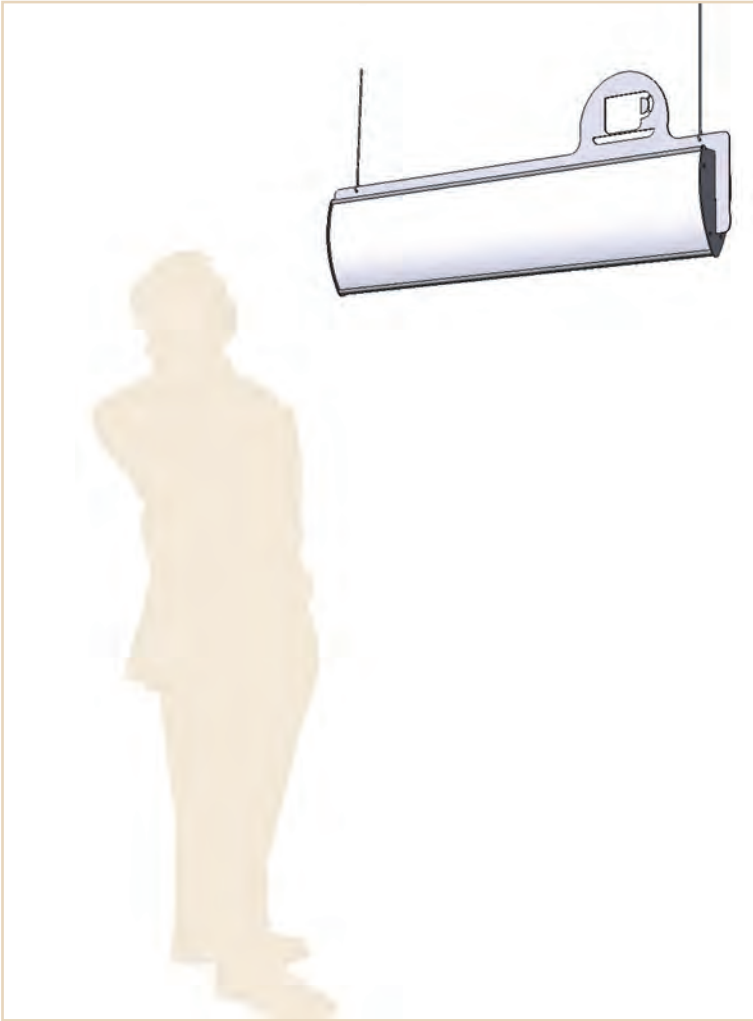

### Cafeteria Pictogram

#### SECT0023

Overall sign size: H 5.88" x W 29.55"  
H 149.3mm x 750mm

Insert size: 5.83" x 27.95" (148mm 710mm)

■ Use a well placed suspended sign with an elegant pictogram to direct visitors to the cafeteria and restroom areas. Updating is quick and easy: just remove the printed insert and replace it with a new one. Braille inserts are supported.



Restrooms pictogram

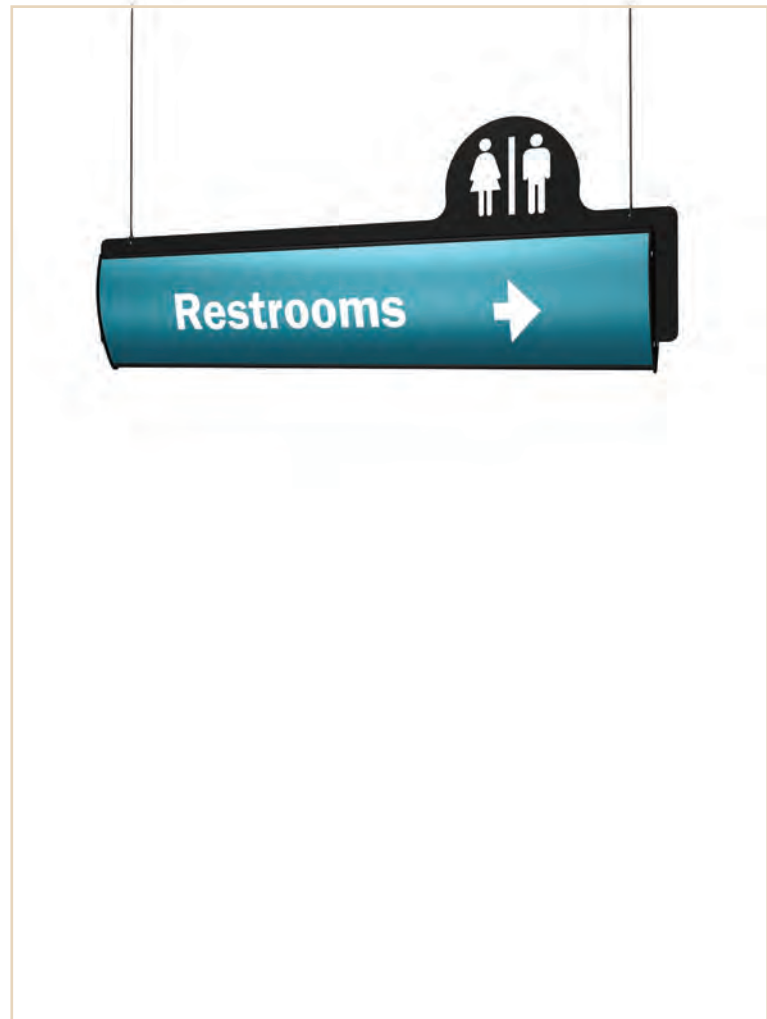
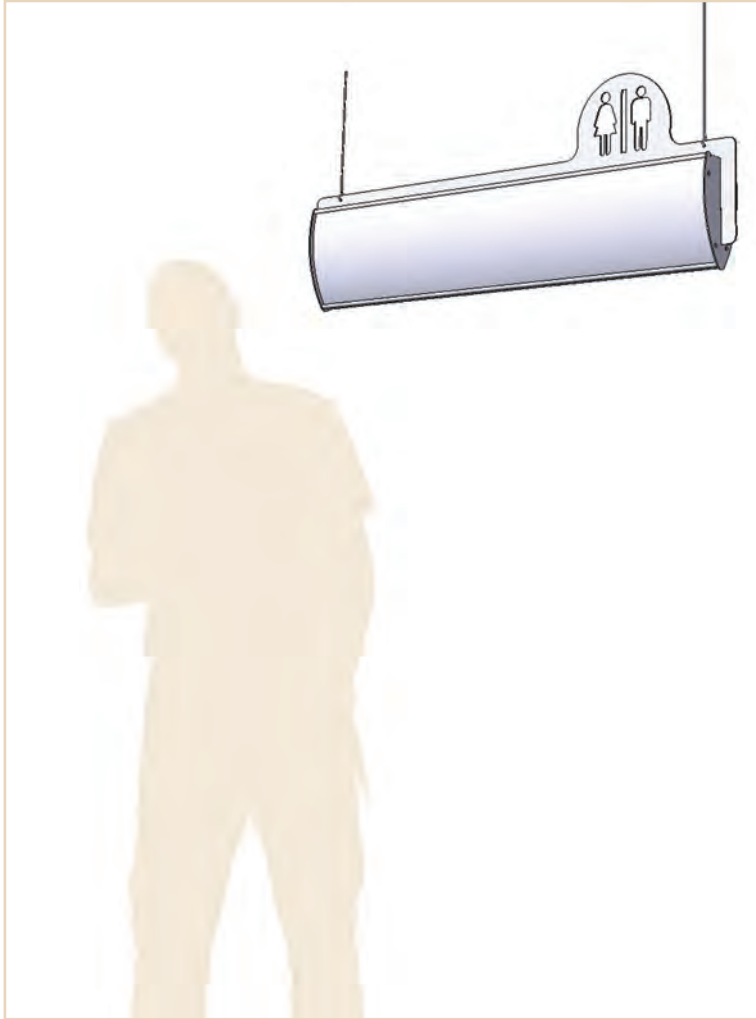

## Restrooms pictogram

### SECT0025

Overall sign size: H 5.88" x W 29.55"  
 H 149.3 mm x W 750mm

Insert size: 5.82" x 27.55" (148mm x 700mm)

■ Use a well placed suspended sign with an elegant pictogram to direct visitors to the cafeteria and restroom areas. Updating is quick and easy: just remove the printed insert and replace it with a new one. Braille inserts are supported.



Toilets

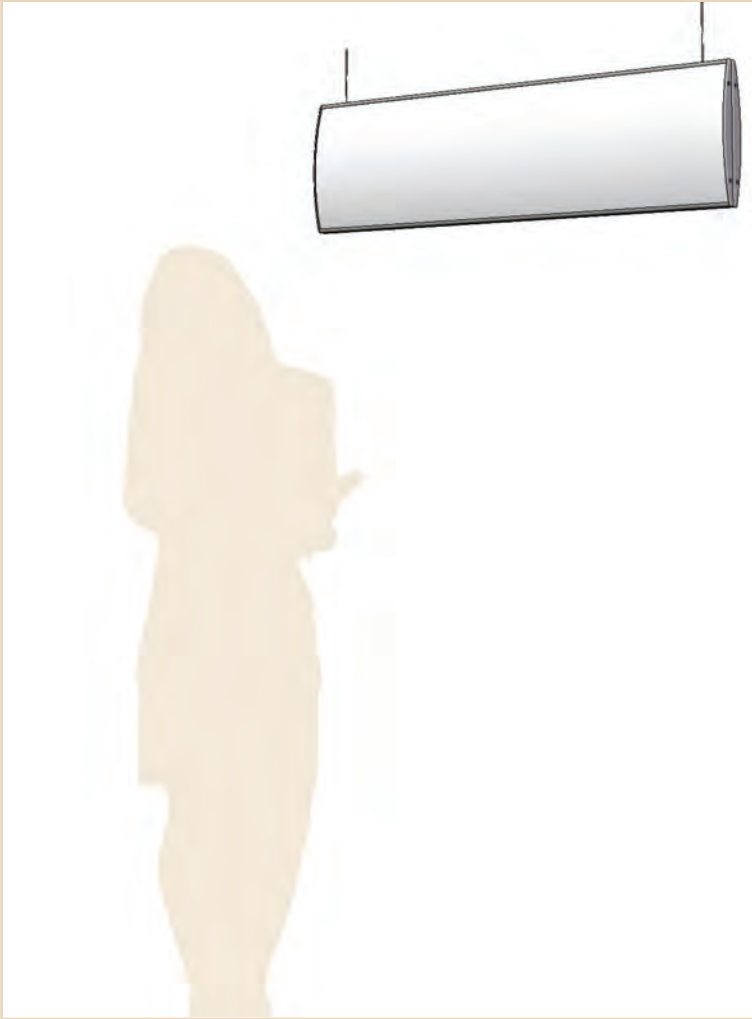

## Toilets

### SECT0061

Overall sign size: H 8" x W 28.1"  
H 204.4mm x W 714mm

Insert size: 7.68" x 27.95" (195mm x 710mm)

■ Use a well placed suspended sign to direct visitors to the restroom area. Updating is quick and easy: just remove the printed insert and replace it with a new one. Braille inserts are supported.



Floor Directory

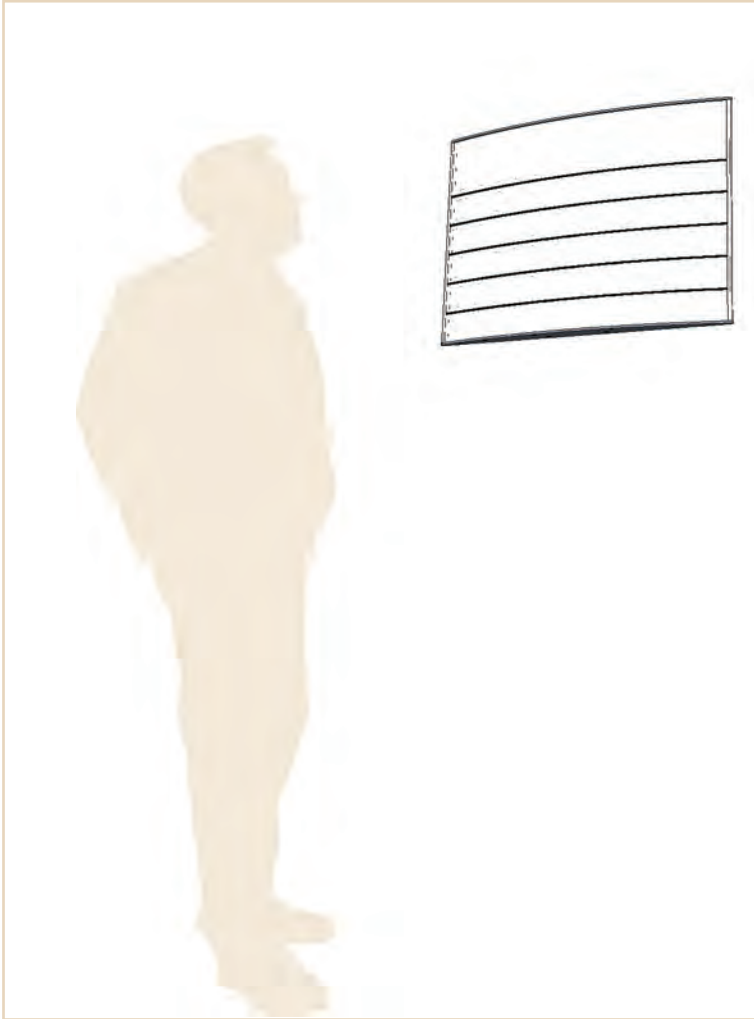

### Floor Directory

#### SECT0058

Overall sign size: H 22.2" x W 32.3"  
H 564mm x W 819mm

Insert size: 5.98" x 31.93", 2.99" x 31.93"  
152mm x 811mm , 76mm x 811mm

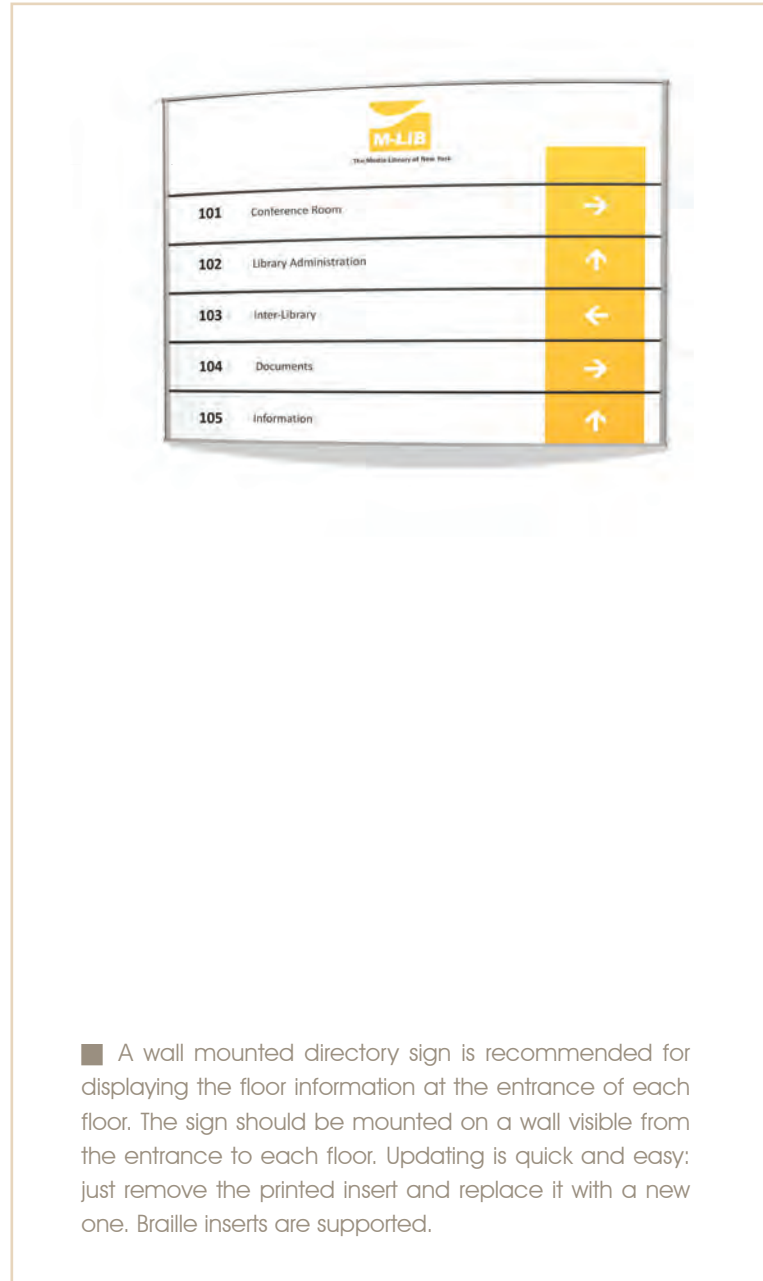

■ A wall mounted directory sign is recommended for displaying the floor information at the entrance of each floor. The sign should be mounted on a wall visible from the entrance to each floor. Updating is quick and easy: just remove the printed insert and replace it with a new one. Braille inserts are supported.



Reading room

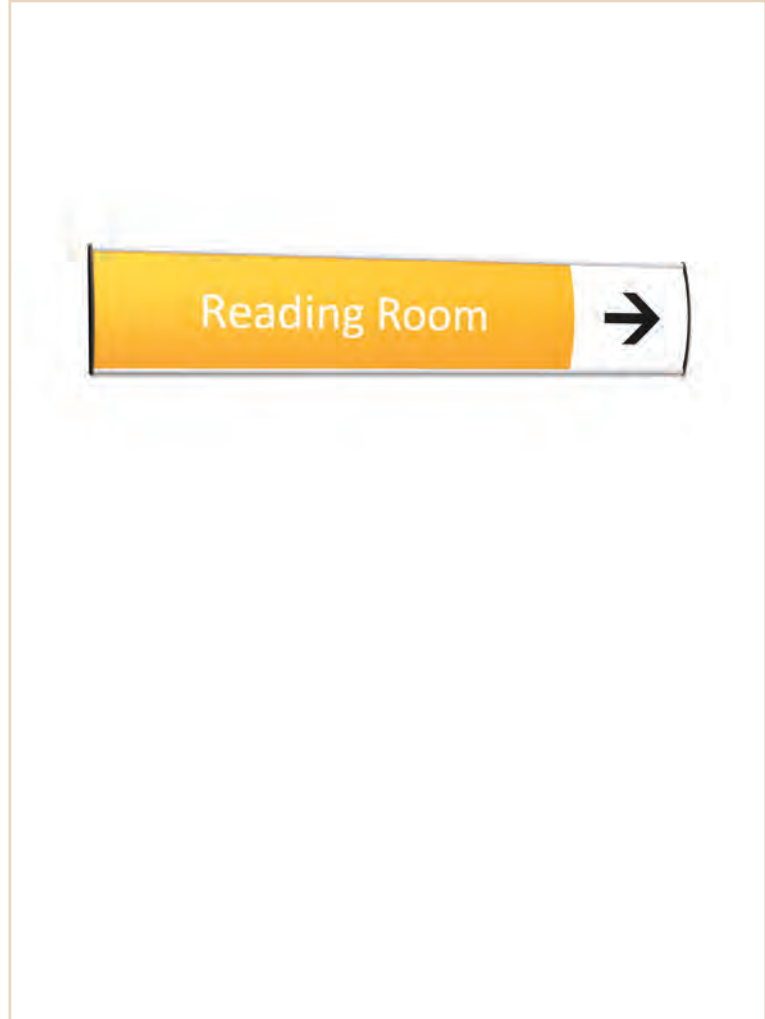
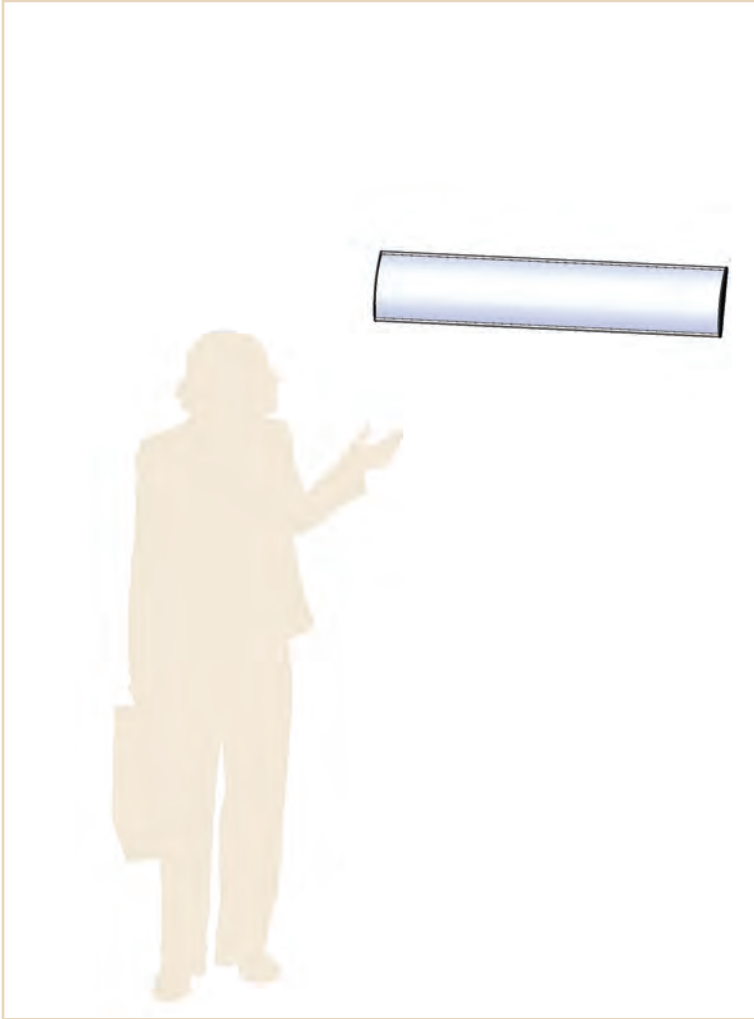

## Reading room

### SECT0059

Overall sign size: H 4.84" x W 25"  
H 123mm x 634mm

Insert size: 4.65" x 24.8" (118mm x 630mm)

■ Use well placed wall mounted signs to direct visitors to areas like the reading room. Wall frames are very versatile. They come in many sizes and types and can be easily mounted. Updating is quick and easy: just remove the printed insert and replace it with a new one. Braille inserts are supported.

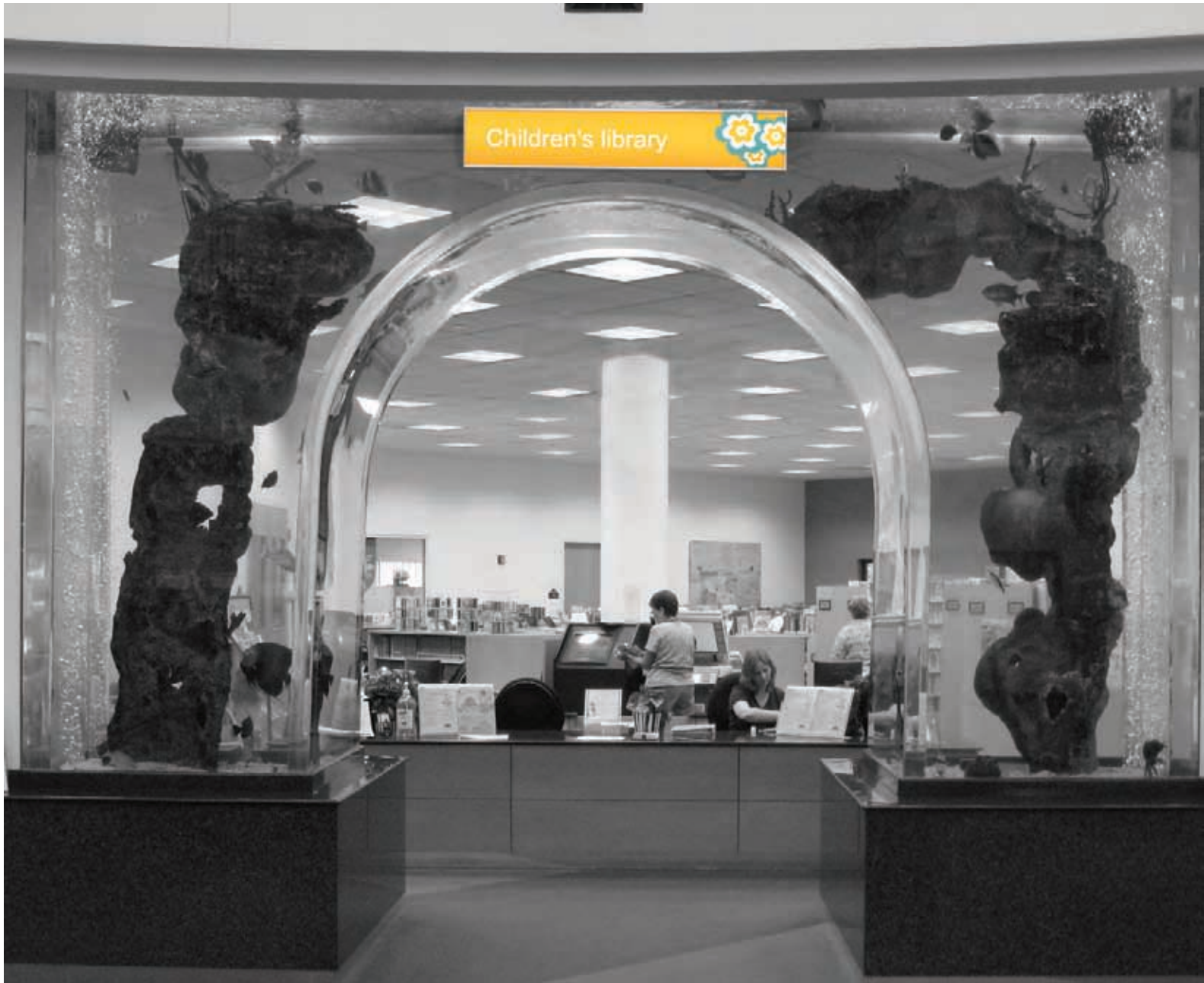

Children's library



### Children's library

#### SECT0059

Overall sign size: H 4.84" x W 25"  
H 123mm x W 634mm

Insert size: 4.65" x 24.8" (118mm x 630mm)

■ Use well placed wall mounted signs to direct visitors to areas like the children's library. Wall frames are very versatile. They come in many sizes and types and can be easily mounted. Updating is quick and easy: just remove the printed insert and replace it with a new one. Braille inserts are supported.



Recycling bin

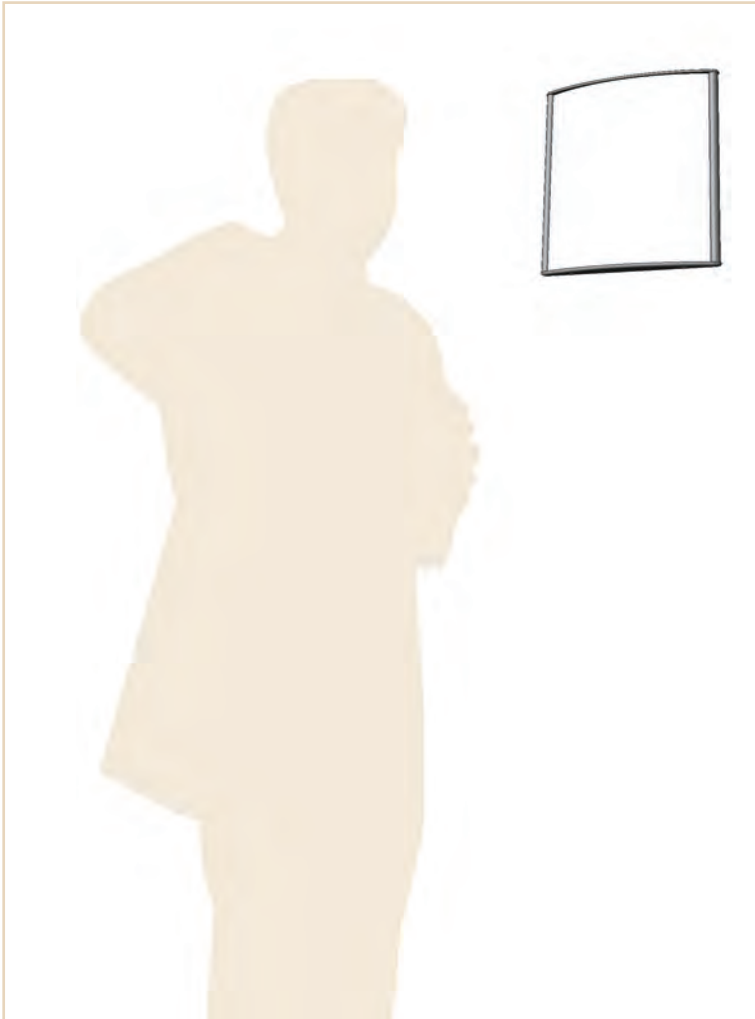

### Recycling bin

**WFP30**

Overall sign size: H 6.1" x W 6"  
 H 155mm x W 153mm

Insert size: 5.09" x 5.83" (150mm x 148mm)

■ Use well placed wall mounted signs to direct visitors to areas like the recycling bin. Wall frames are very versatile. They come in many sizes and types and can be easily mounted. Updating is quick and easy: just remove the printed insert and replace it with a new one. Braille inserts are supported.



Room identification

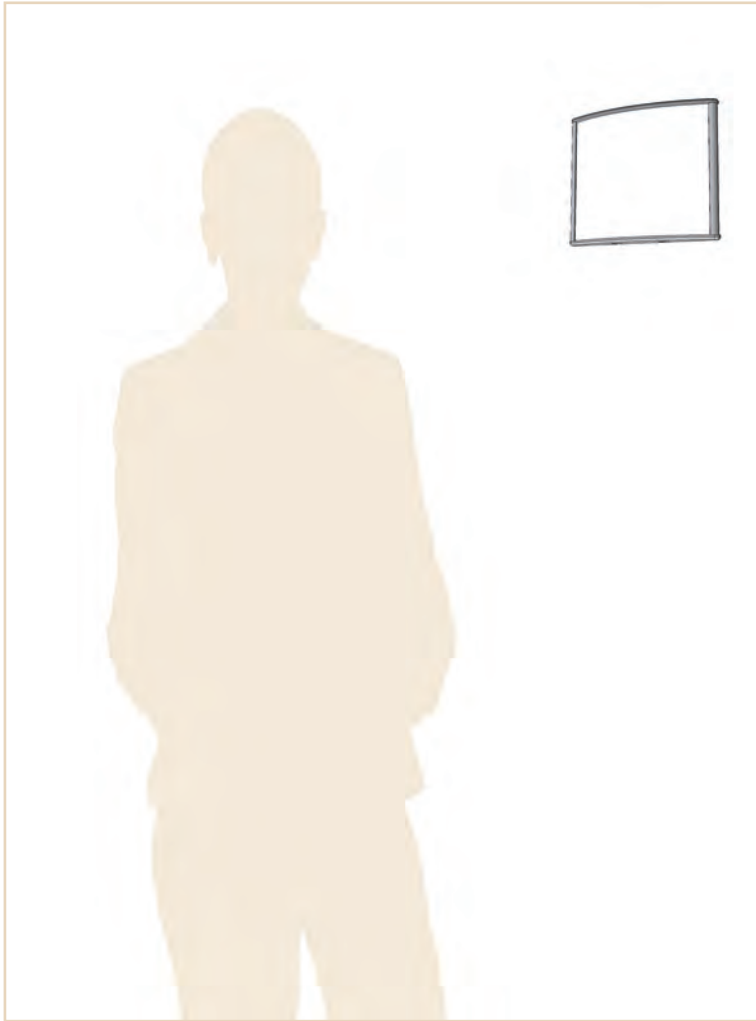

## Room identification

### WFP2

Overall sign size: H 3.15" x W 4"  
H 80mm x W 102mm

Insert size: 2.95" x 3.83" (75mm x 97.5mm)

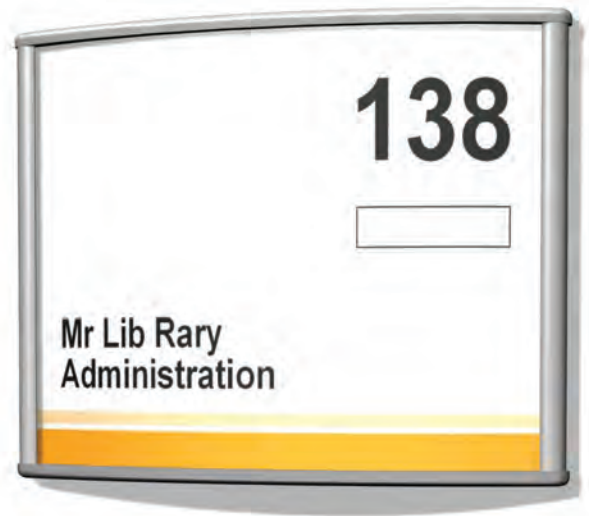

■ Use well placed wall mounted signs to direct visitors to areas like the room identification. Wall frames are very versatile. They come in many sizes and types and can be easily mounted. Updating is quick and easy; just remove the printed insert and replace it with a new one. Braille inserts are supported.



Trash bin



## Trash bin

### SECT0024

Overall sign size: H 6" x W 15.15"  
H 153mm x W 385mm

Insert size: 5.83" x 9.84" (148mm x 250mm)

■ Use well placed wall mounted signs to direct visitors to areas like the trash bins. Wall frames are very versatile. They come in many sizes and types and can be easily mounted. Updating is quick and easy: just remove the printed insert and replace it with a new one. Braille inserts are supported.



Toilets & coats and luggage checking

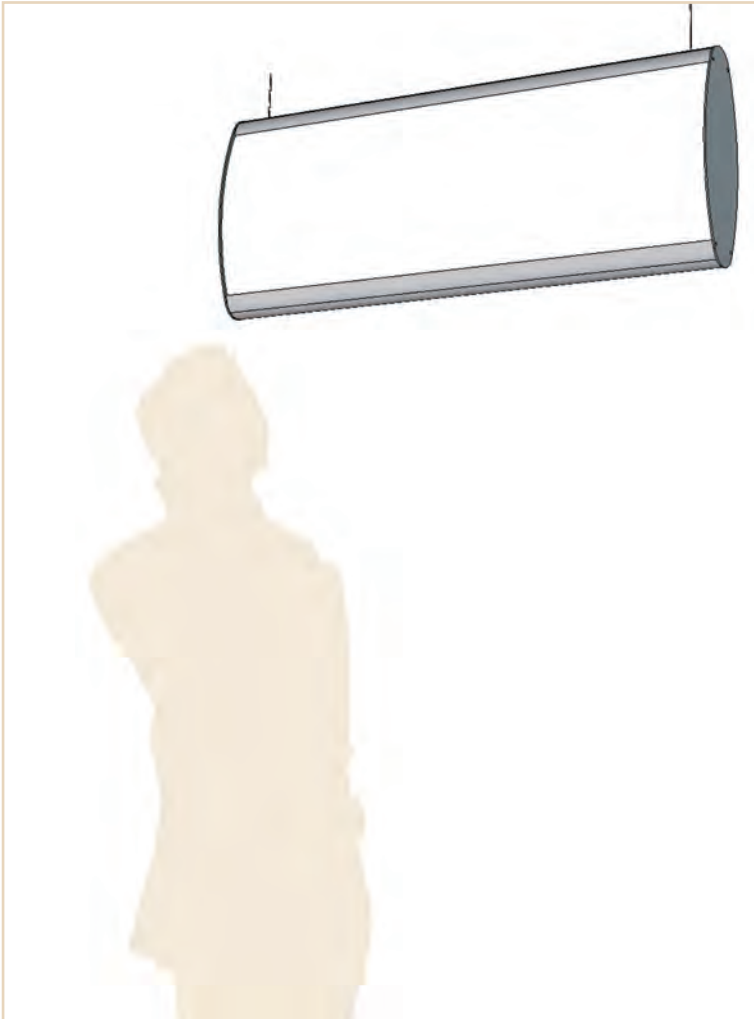

### Toilets & coats and loggage checking **SUSVL8**

Overall sign size: H 14.4" x W 36"  
H 364.3mm x W 916mm

Insert size: 12.01" x 35.83" (305mm x 910mm)

■ Use a well placed illuminated suspended sign to direct visitors various locations of the library. Suspended signs are very flexible; they come in many sizes and types and can be easily mounted to the ceiling. Updating is quick and easy; you just pop out the printed insert and replace it with a new one.

MCFT - A modular system with the ability to provide highly customizable solutions that meet the unique requirements of each sign project.

## Facilities

Every library offers a range of facilities for its visitors, such as reading rooms, Wi-Fi terminals, elevators, information, and luggage rooms. These facilities must be well identified by proper signage.

Choose the right product for you and order today from your preferred Vista System sign dealer.





Coat checking

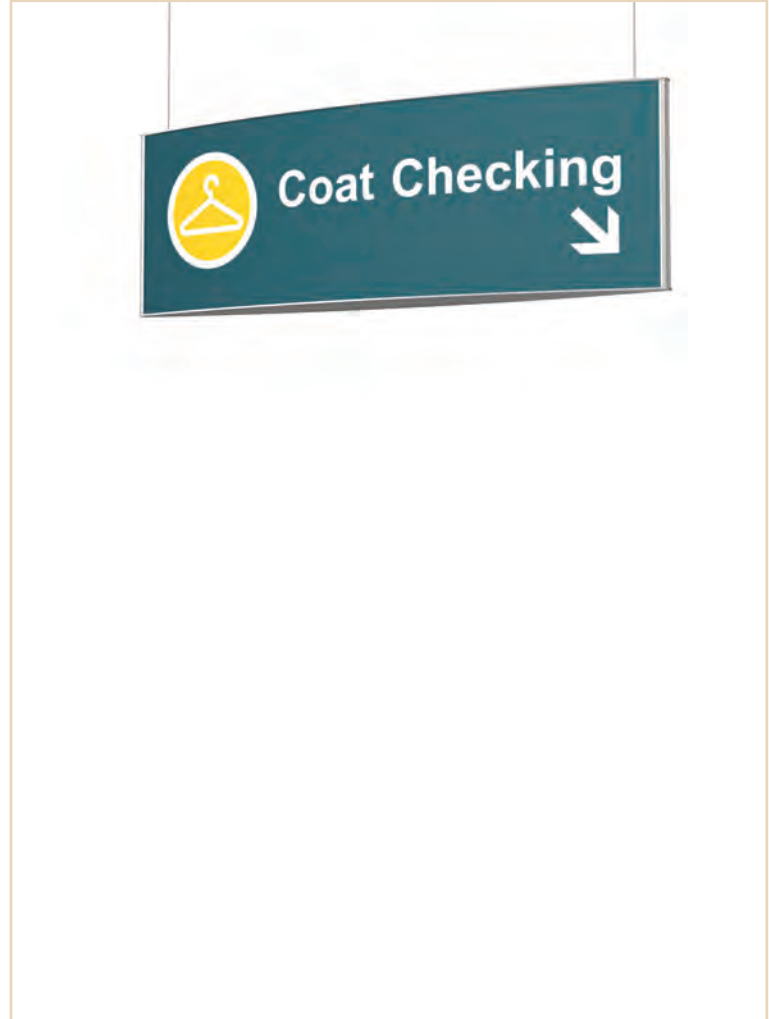
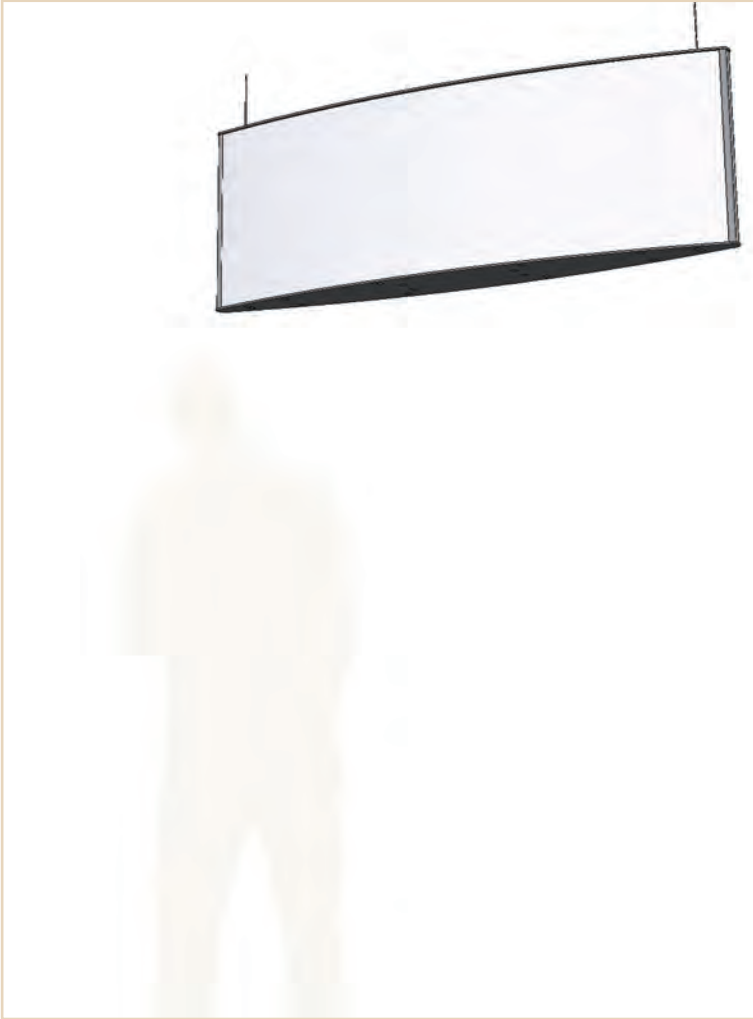

## Coat checking

### SECT0056

Overall sign size: H 12" x W 36.2"  
H 306mm x W 919mm

Insert size: 11.81" x 35.9" (300mm x 912mm)

■ Use a well placed suspended sign to direct visitors to the coats checking position. Suspended signs are very flexible; they come in many sizes and types and can be easily mounted to the ceiling. Updating is quick and easy; you just pop out the printed insert and replace it with a new one.

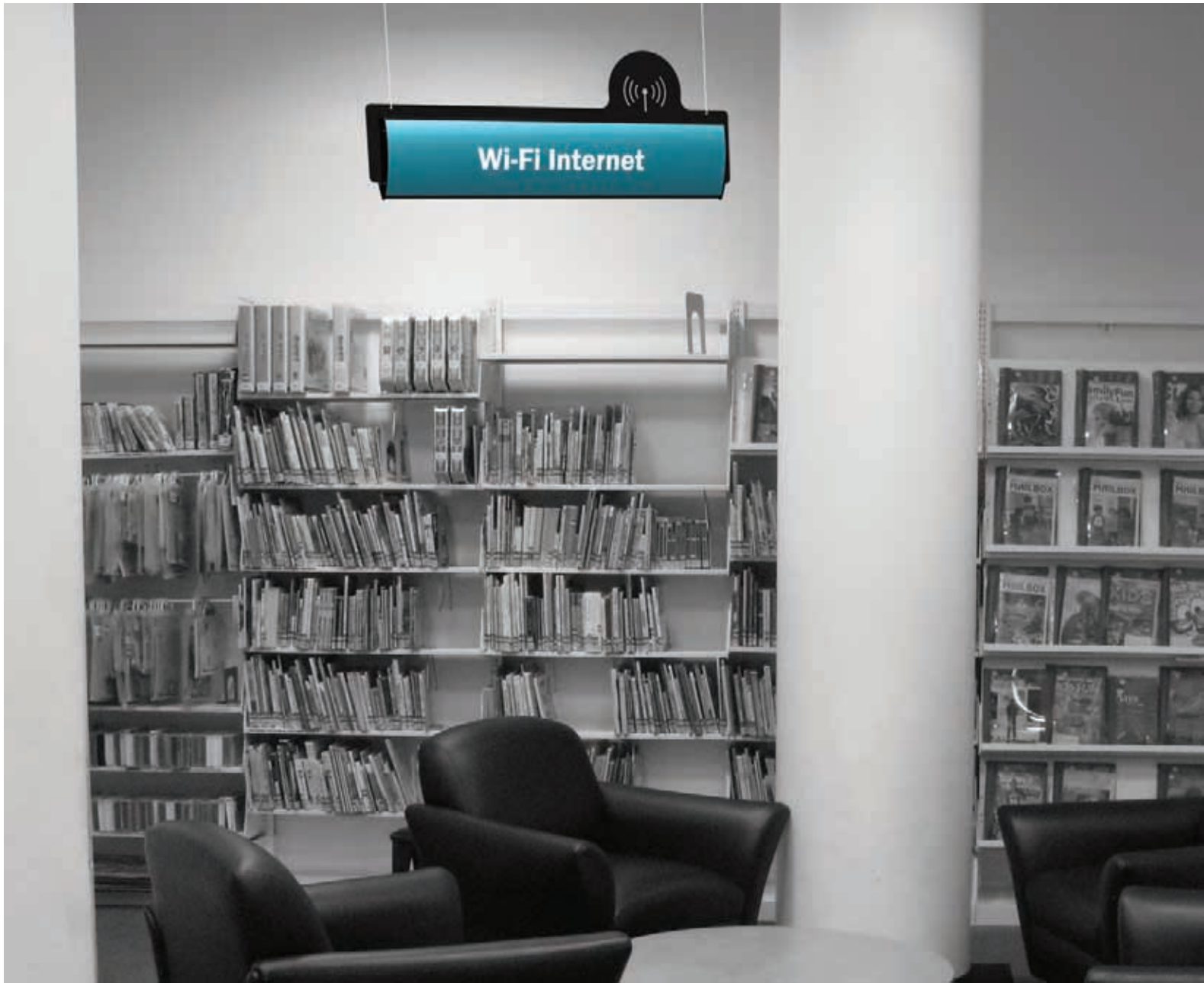

Wi-Fi Internet

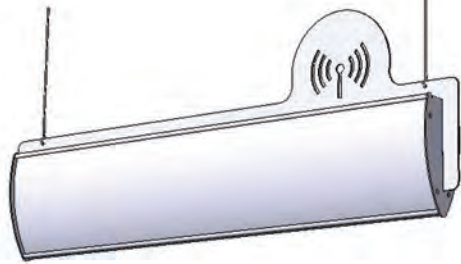

## Wi-Fi Internet

### SECT0014

Overall sign size: H 11.3" x W 29.55"  
H 286mm x W 750mm

Insert size: 5.82" x 27.55" (148mm x 700mm)

■ Use a well placed suspended sign to direct visitors to the Wi-Fi Internet. Suspended signs are very flexible; they come in many sizes and types and can be easily mounted to the ceiling. Updating is quick and easy; you just pop out the printed insert and replace it with a new one.



Luggage checking

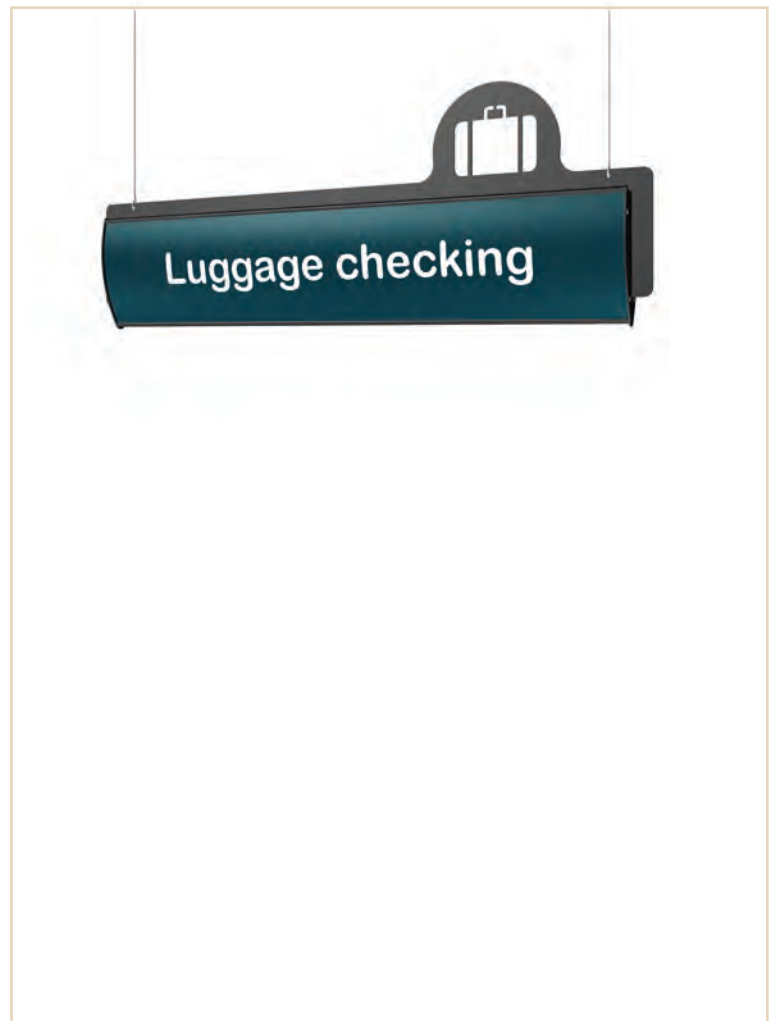
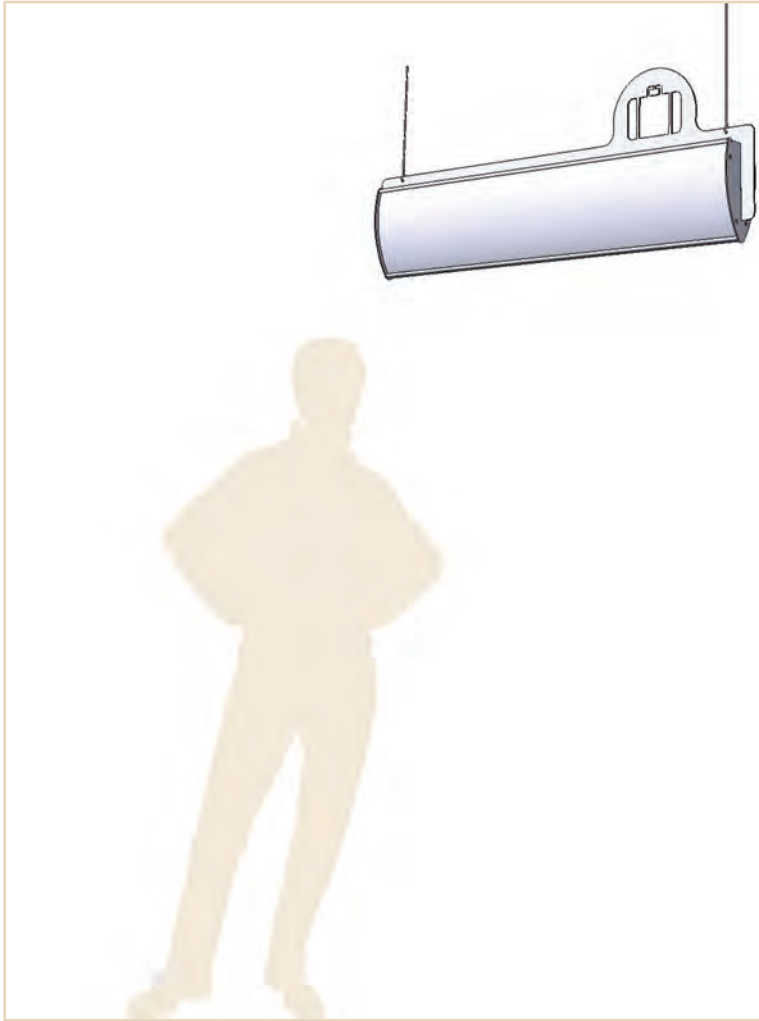

## Luggage checking

### SECT0016

Overall sign size: H 11.3" x W 29.55"  
H 286mm x W 750mm

Insert size: 5.82" x 27.55" (148mm x 700mm)

■ Use a well placed suspended sign to direct visitors to the Luggage checking room. Suspended signs are very flexible; they come in many sizes and types and can be easily mounted to the ceiling. Updating is quick and easy; you just pop out the printed insert and replace it with a new one.



Information

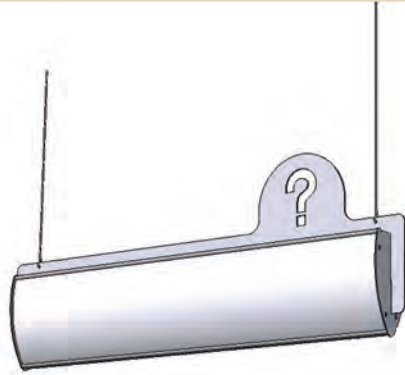

## Information

### SECT0017

Overall sign size: H 11.3" x W 29.55"

H 286mm x W 750mm

Insert size: 5.82" x 27.55" (148mm x 700mm)

■ Use a well placed suspended sign to direct visitors to the Information terminal. Suspended signs are very flexible; they come in many sizes and types and can be easily mounted to the ceiling. Updating is quick and easy; you just pop out the printed insert and replace it with a new one.



Elevator

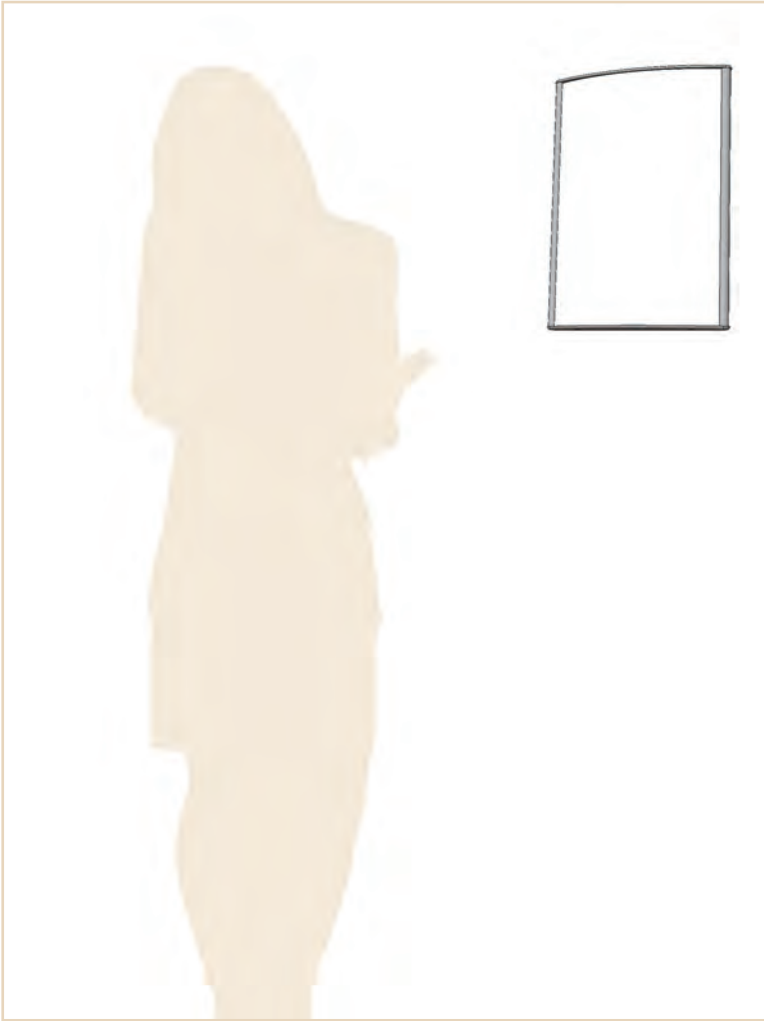

## Elevator

### WFP30

Overall sign size: H 6.2" x W 6"  
H 155mm x W 151mm

Insert size: 5.9" x 5.82" (150mm x 148mm)



■ Use a well placed wall mounted sign to direct visitors to the elevator. Wall frames are very flexible, they come in many sizes and types and can be easily mounted. Updating is quick and easy; you just pop out the printed insert and replace it with a new one. Braille inserts are supported.



Reading room

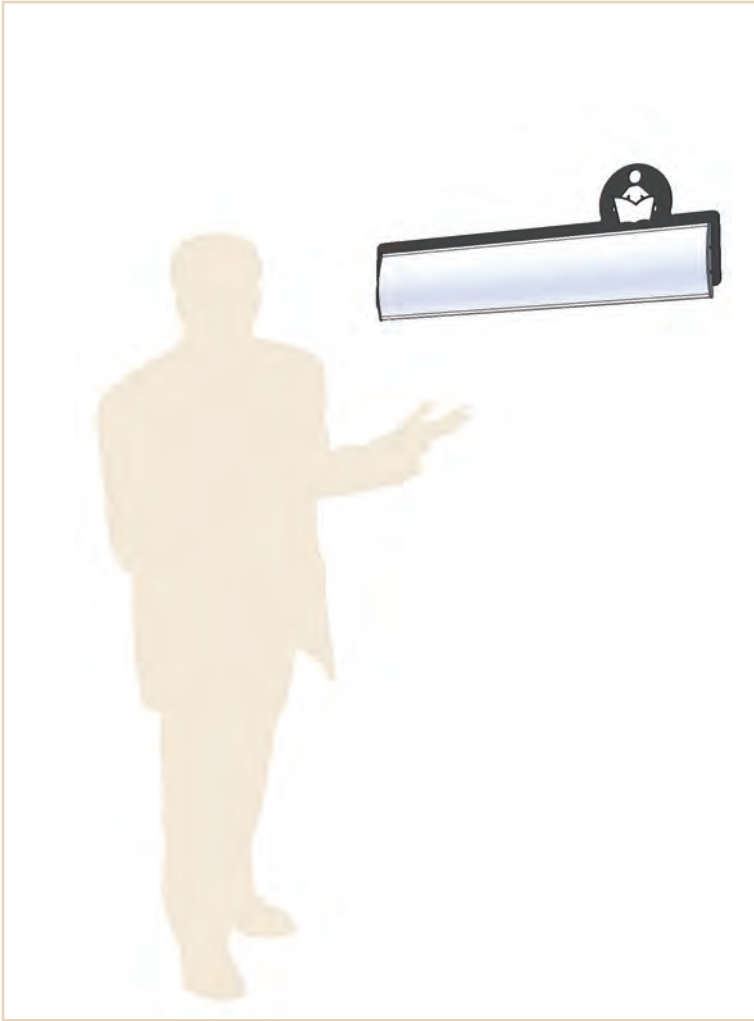

## Reading room

### SECT0018

Overall sign size: H 11.3" x W 29.55"  
H 286mm x W 750mm

Insert size: 4.64" x 24.8" (118mm x 630mm)

■ Use a well placed wall mounted sign to direct visitors to the Reading Room. Wall frames are very flexible, they come in many sizes and types and can be easily mounted. Updating is quick and easy; you just pop out the printed insert and replace it with a new one. Braille inserts are supported.

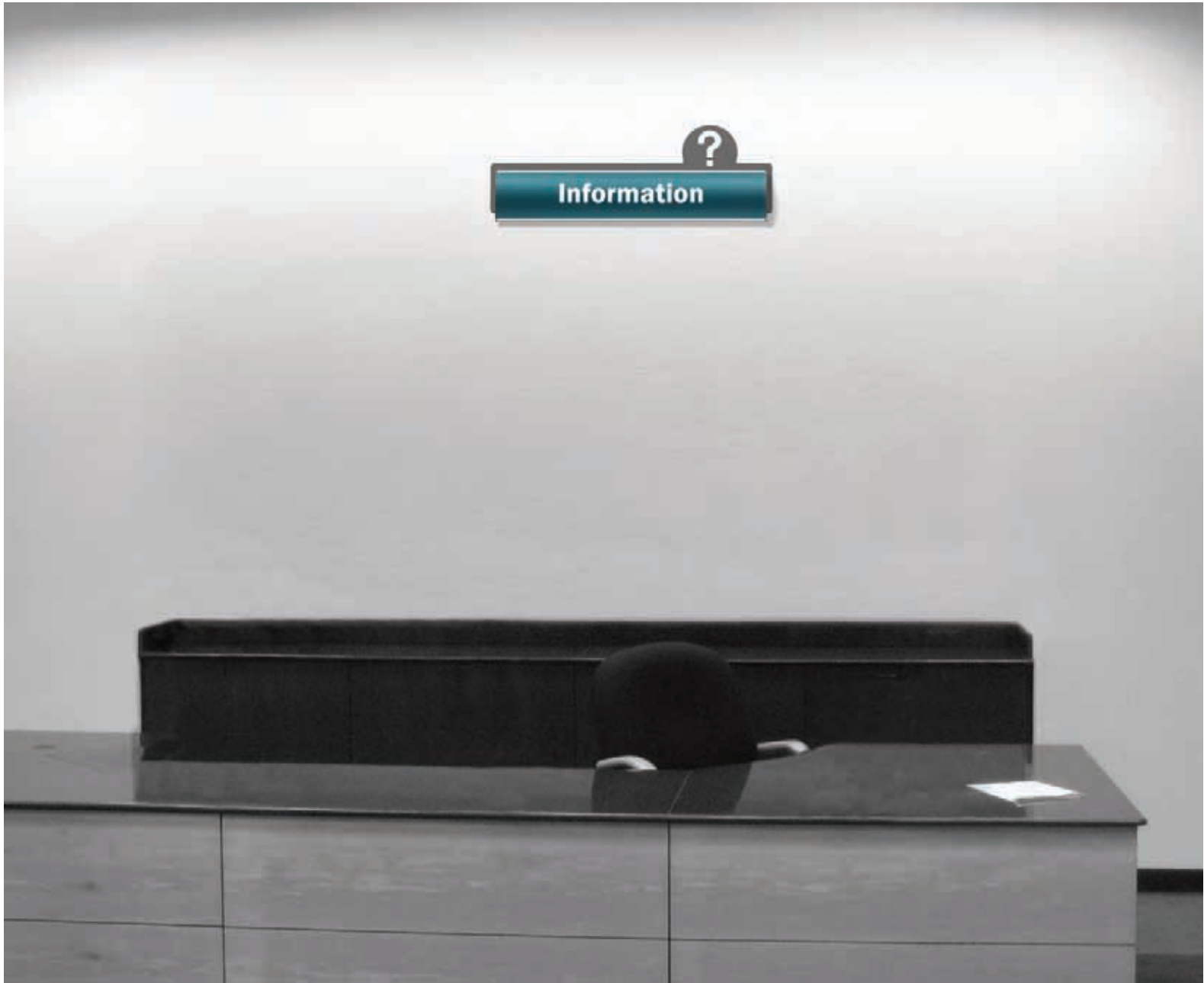

Information

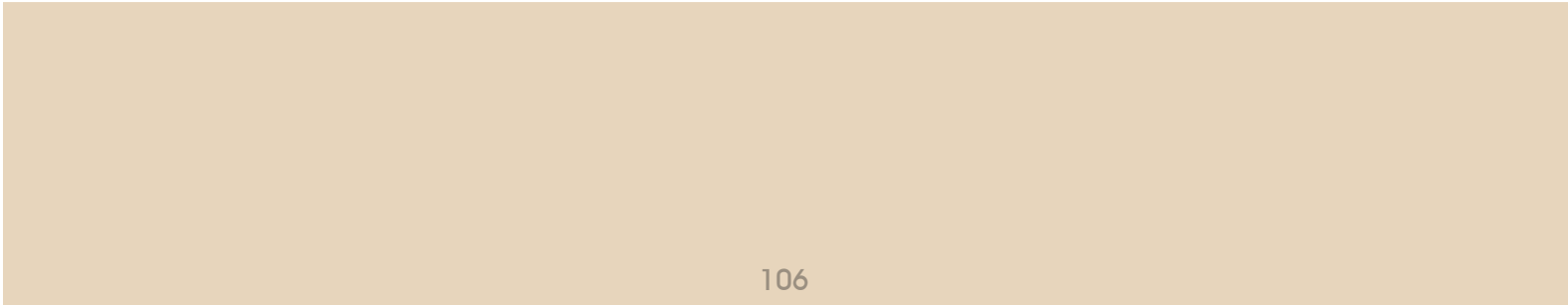

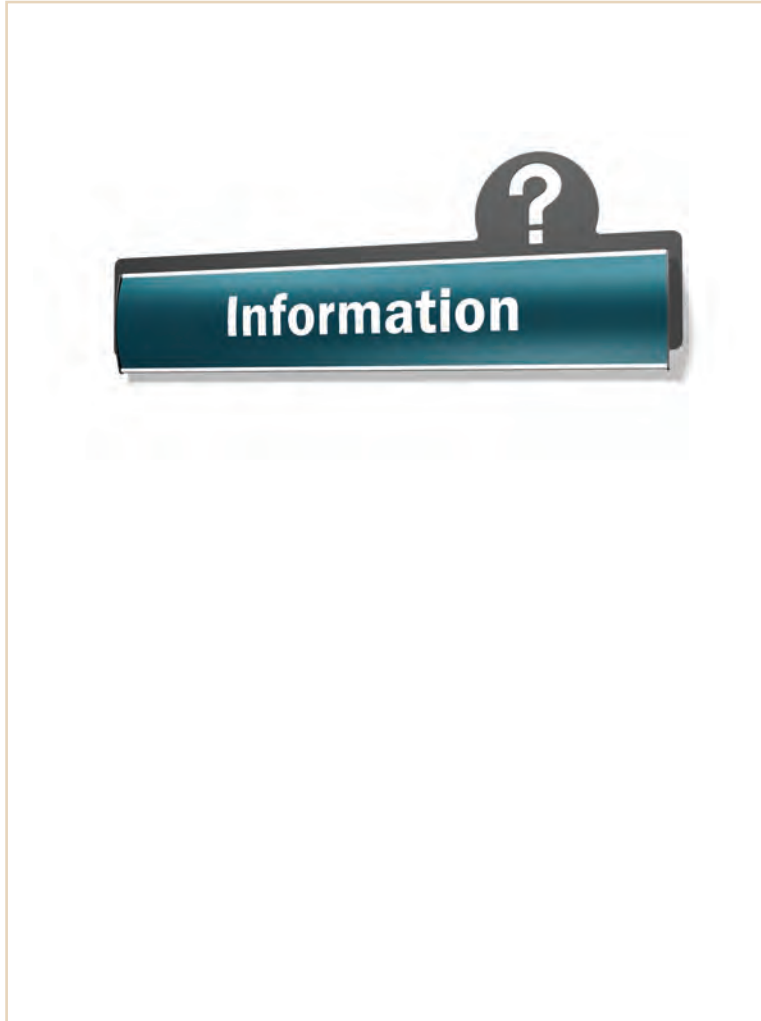

## Information

### SECT0019

Overall sign size: H 11.3" x W 29.55"  
 H 286mm x W 750mm

Insert size: 4.64" x 24.8" (118mm x 630mm)

■ Use a well placed wall mounted sign to direct visitors to the Information terminal. Wall frames are very flexible, they come in many sizes and types and can be easily mounted. Updating is quick and easy; you just pop out the printed insert and replace it with a new one. Braille inserts are supported.



Cafeteria

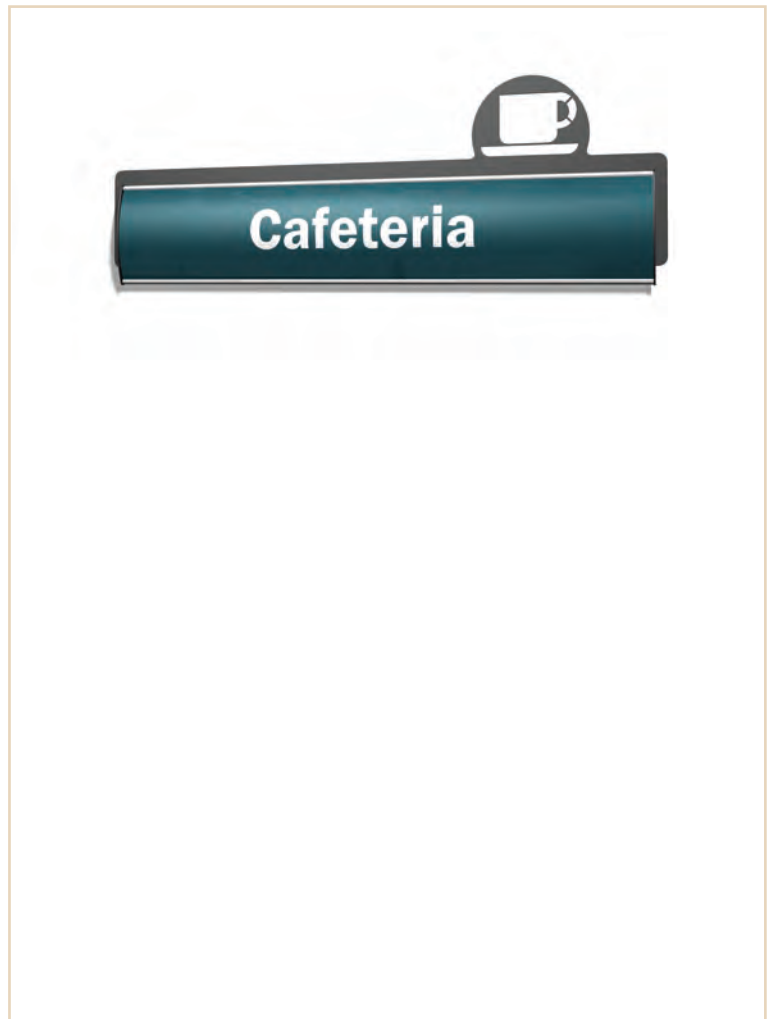

## Cafeteria

### SECT0020

Overall sign size: H 11.3" x W 29.55"  
H 286mm x W 750mm

Insert size: 4.64" x 24.8" (118mm x 630mm)

■ Use a well placed wall mounted sign to direct visitors to the Cafeteria. Wall frames are very flexible, they come in many sizes and types and can be easily mounted. Updating is quick and easy; you just pop out the printed insert and replace it with a new one. Braille inserts are supported.

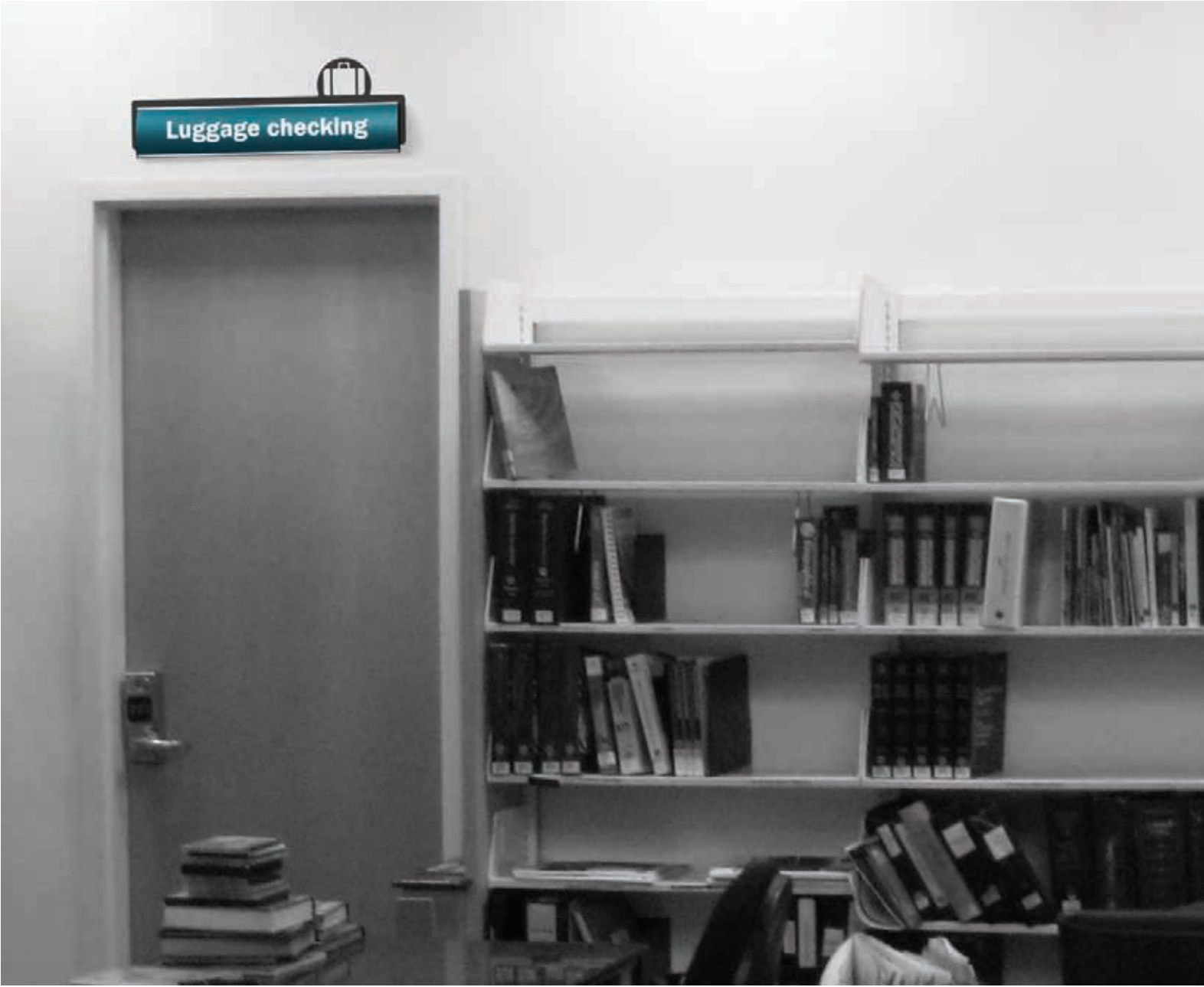

Luggage checking

Luggage checking

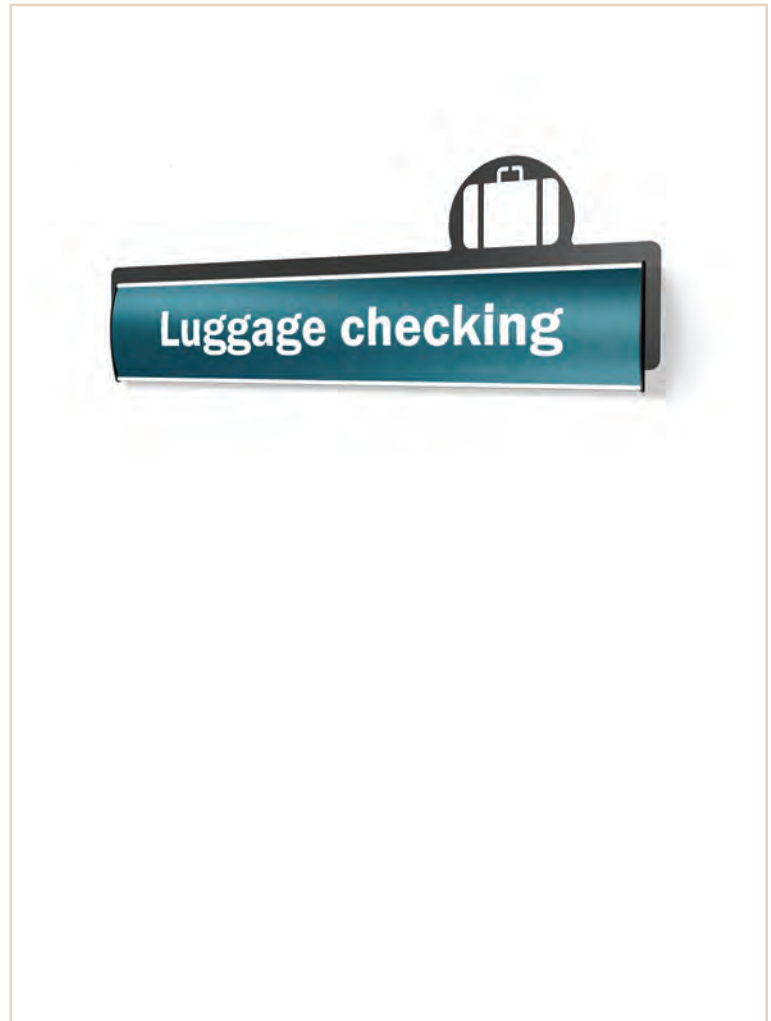

## Luggage checking

**SECT0021**

Overall sign size: H 11.3" x W 29.55"  
H 286mm x W 750mm

Insert size: 4.64" x 24.8" (118mm x 630mm)

■ Use a well placed wall mounted sign to direct visitors to the Luggage checking room. Wall frames are very flexible, they come in many sizes and types and can be easily mounted. Updating is quick and easy; you just pop out the printed insert and replace it with a new one. Braille inserts are supported.

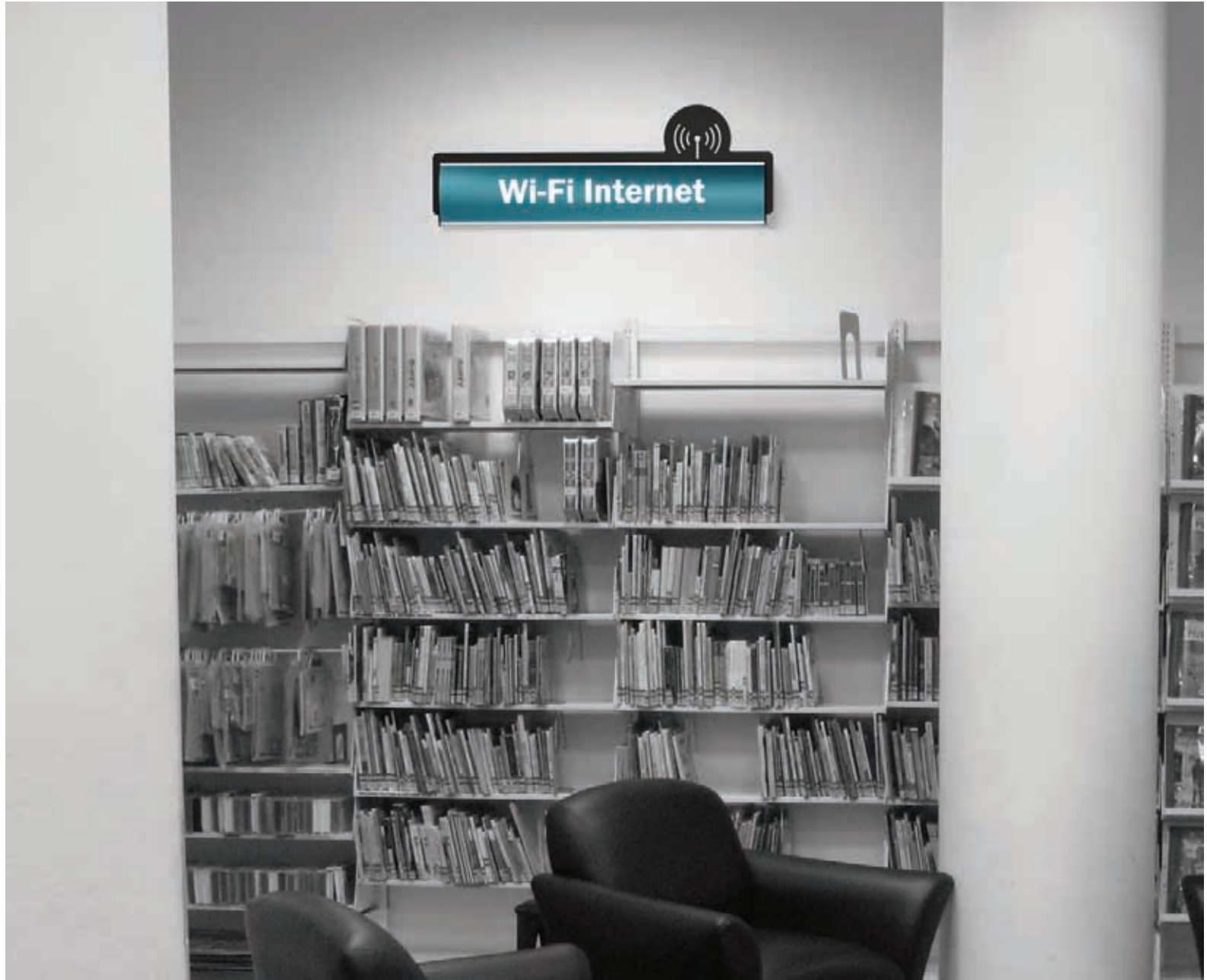

Wi-Fi Internet



## Wi-Fi Internet

### SECT0022

Overall sign size: H 11.3" x W 29.55"  
H 286mm x W 750mm

Insert size: 4.64" x 24.8" (118mm x 630mm)

■ Use a well placed wall mounted sign to direct visitors to the Wi-Fi Internet terminal. Wall frames are very flexible, they come in many sizes and types and can be easily mounted. Updating is quick and easy; you just pop out the printed insert and replace it with a new one. Braille inserts are supported.

Vista System provides a comprehensive solution with an unrivaled range of applications that covers the entire project for a competitive price.

## Warning Signs

A library is a well organized place. In order to keep it organized and efficient, there must be rules that visitors should obey. One of the most famous library warnings is the "Keep Quiet" sign, but of course there are many more.

Vista System offers a wide selection of elegant and eye catching signs for displaying warning signs that show the rules of the library.

Choose the right product for you and order today from your preferred Vista system sign dealer.





Use of mobile phones is prohibited



### Use of mobile phones is prohibited

#### SECT0062

Overall sign size: H 8.7" x W 7.2"

H 221mm x W 182.7mm

Insert size: 8.5" x 5.83" (216mm x 148mm)



- Use a well placed flag sign to display the library warning signs. The benefit of the flag signs is that they give a needed extra visibility from viewing angles that are not covered by the other signs. Updating is quick and easy, you just pop out the printed insert and replace it with a new one. Braille inserts are supported.



Please keep quiet

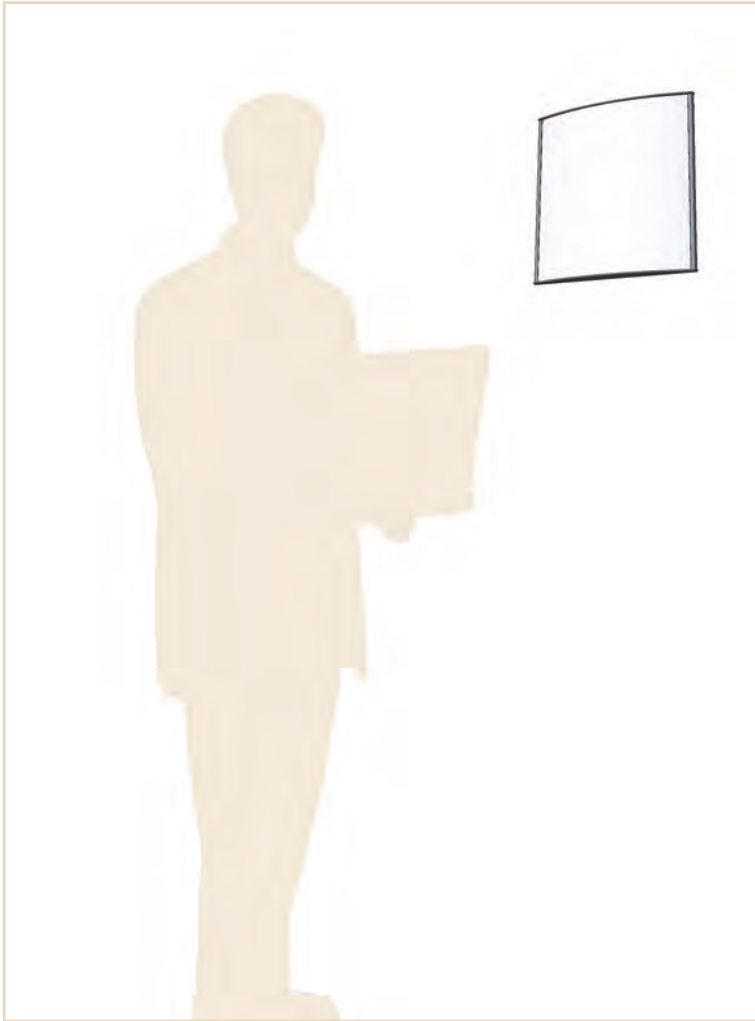

### Please keep quiet

#### SECT0062.2

Overall sign size: H 11.15" x W 11.2"

H 283mm x W 284.5mm

Insert size: 10.98" x 10.98" (279mm x 279mm)



■ Use a well placed flag sign to display the library warning signs. The benefit of the flag signs is that they give a needed extra visibility from viewing angles that are not covered by the other signs. Updating is quick and easy, you just pop out the printed insert and replace it with a new one. Braille inserts are supported.



Do not return books to shelves

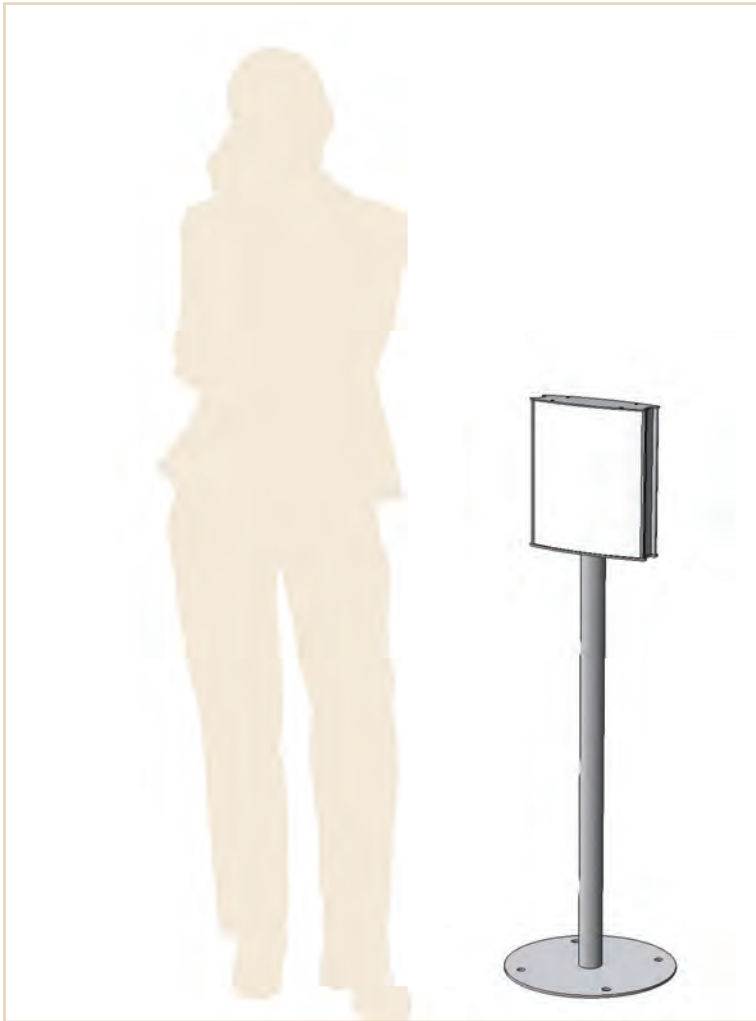

### Do not return books to shelves

#### DSP5

Overall sign size: H 45.4" x W 8.82"  
H 1155mm x W 224mm

Insert size: 11" x 8.54" (279.4mm x 217mm)



■ Post signs are very effective for displaying warning messages. They are mobile and can be moved to any location when an extra warning sign is needed. They are excellent for displaying messages along the library that the visitors wouldn't overlook. Updating is quick and easy, you just pop out the printed insert and replace it with a new one. Braille inserts are supported.



No smoking

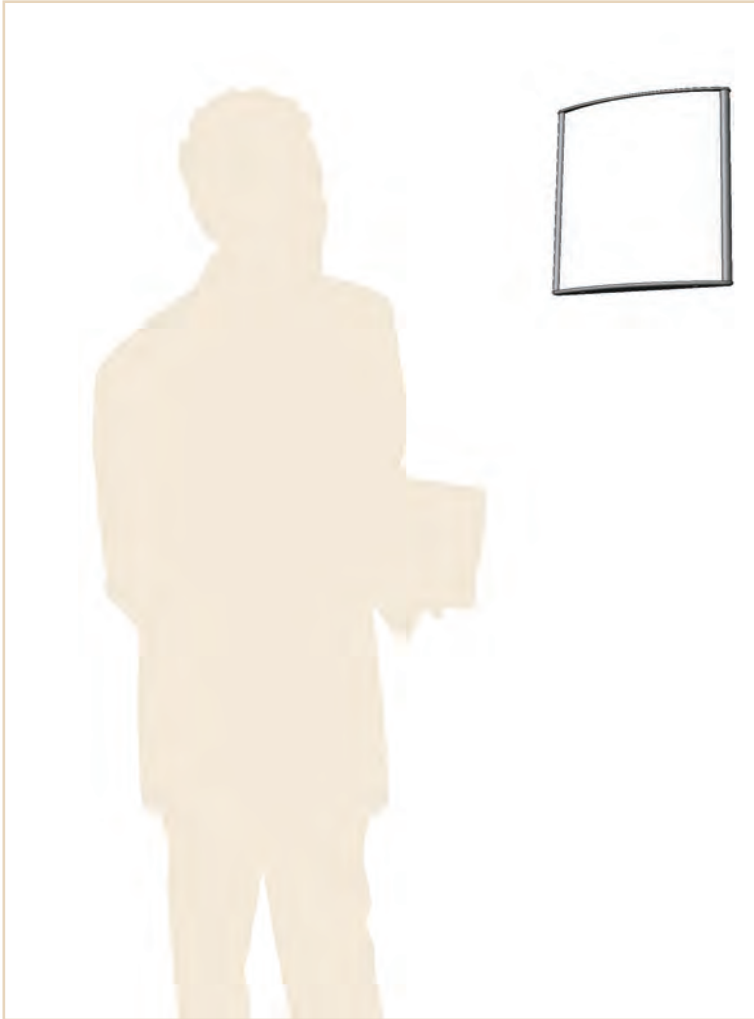

## No smoking

### WFP30

Overall sign size: H 6.2" x W 6"  
H 155mm x W 151mm

Insert size: 5.9" x 5.83" (150mm x 148mm)

- Use a well placed wall frame to display warning messages along the library's walls. Updating is quick and easy; you just pop out the printed insert and replace it with a new one. Braille inserts are supported.



Litter disposal

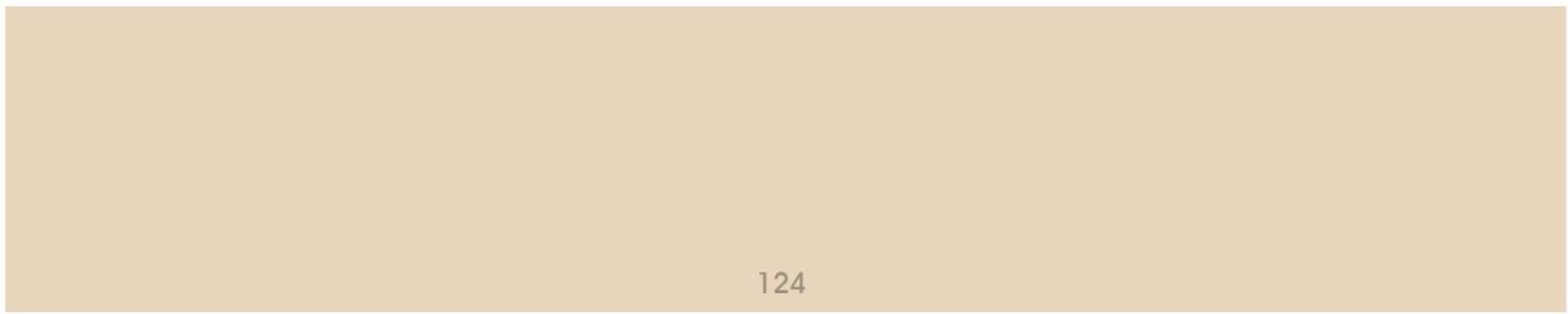

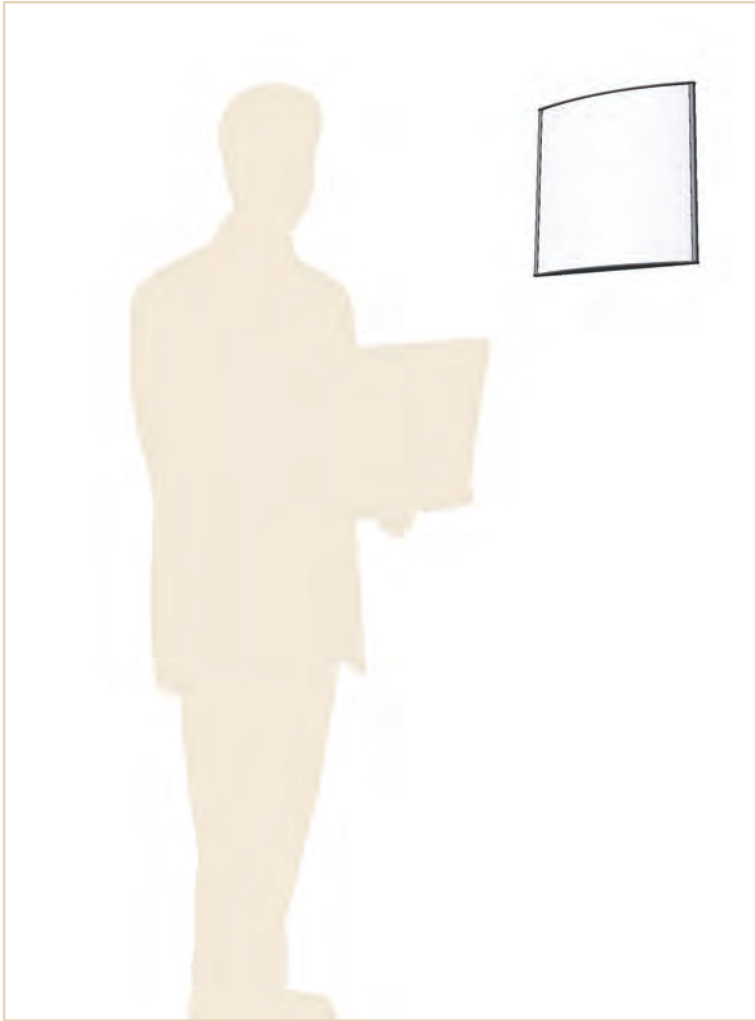

### Litter disposal

#### WFP164

Overall sign size: H 11.15" x W 11.2"  
H 283mm x W 284.5mm

Insert size: 10.98" x 10.98" (279mm x 279mm)



- Use a well placed wall frame to display warning messages along the library's walls. Updating is quick and easy; you just pop out the printed insert and replace it with a new one. Braille inserts are supported.



Eating is prohibited

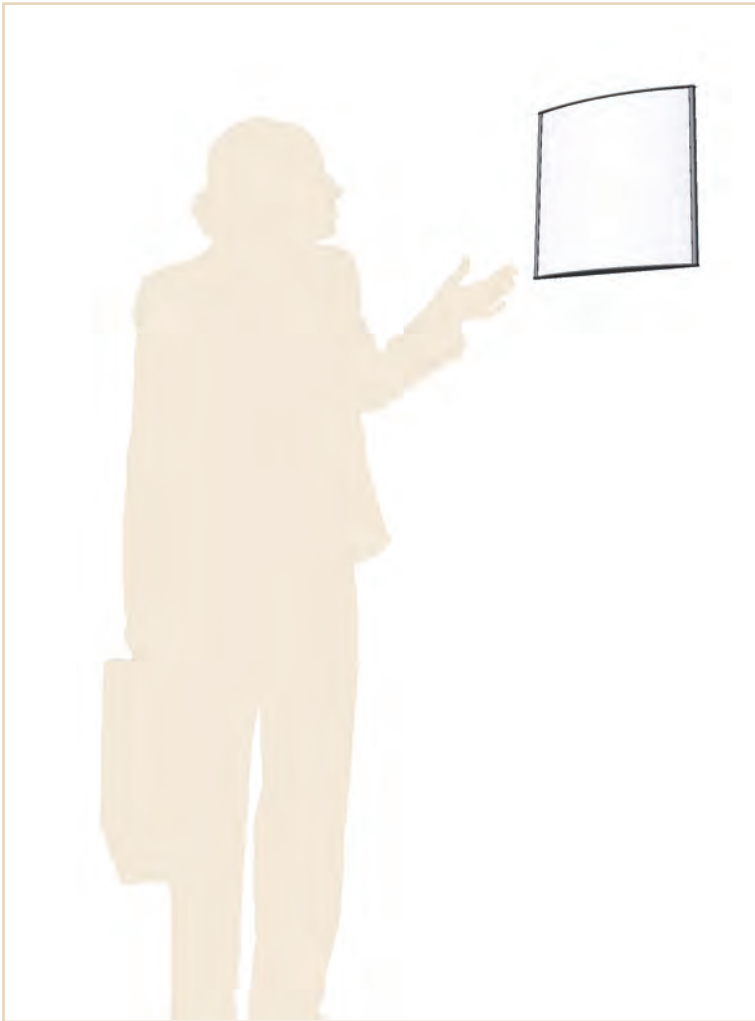

### Eating is prohibited

#### WFP164

Overall sign size: H 11.15" x W 11.2"  
H 283mm x W 284.5mm

Insert size: 10.98" x 10.98" (279mm x 279mm)

- Use a well placed wall frame to display warning messages along the library's walls. Updating is quick and easy; you just pop out the printed insert and replace it with a new one. Braille inserts are supported.



No entry- employees only

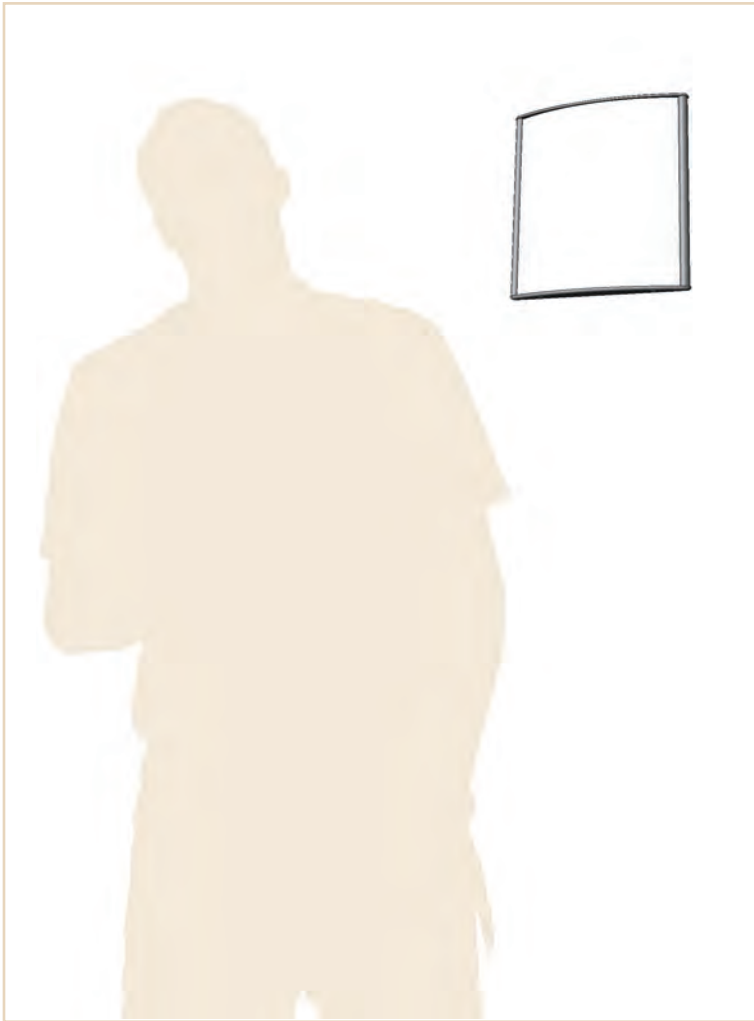

**No entry- employees only**

**WFP30**

Overall sign size: H 6.2" x W 6"  
H 155mm x W 151mm

Insert size: 5.9" x 5.8" (150mm x 148mm)

- Use a well placed wall frame to display warning messages along the library's walls. Updating is quick and easy; you just pop out the printed insert and replace it with a new one. Braille inserts are supported.



No smoking pictogram

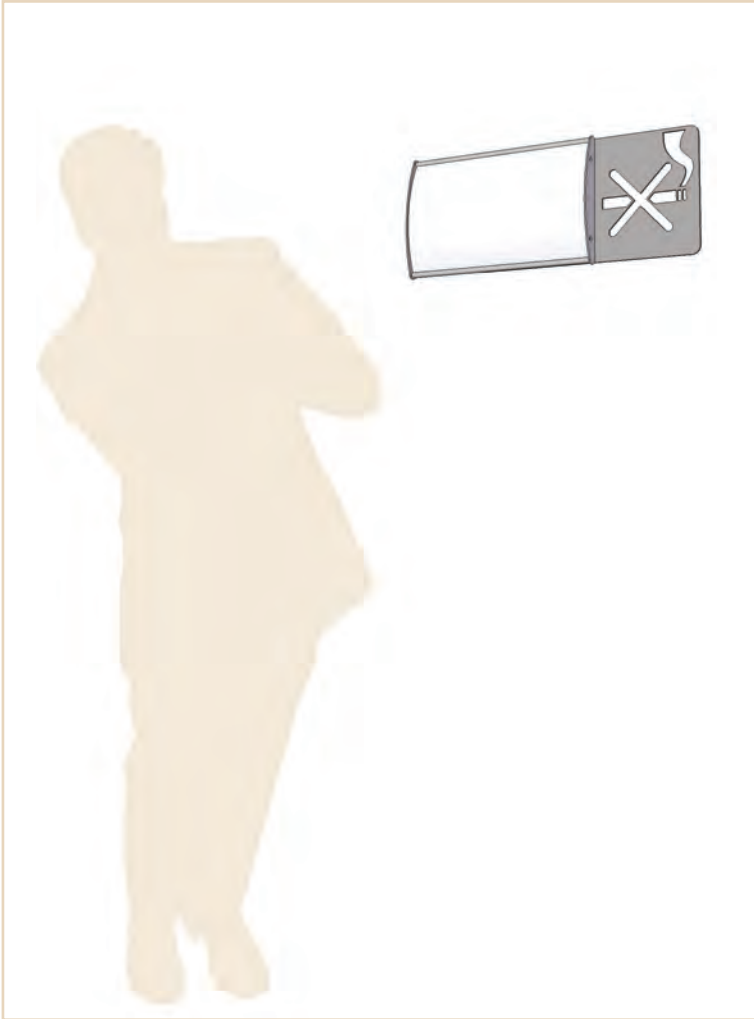

## No smoking pictogram

### SECT0027

Overall sign size: H 6" x W 15.15"  
H 153mm x W 385mm

Insert size: 5.83" x 9.84" (148mm x 250mm)

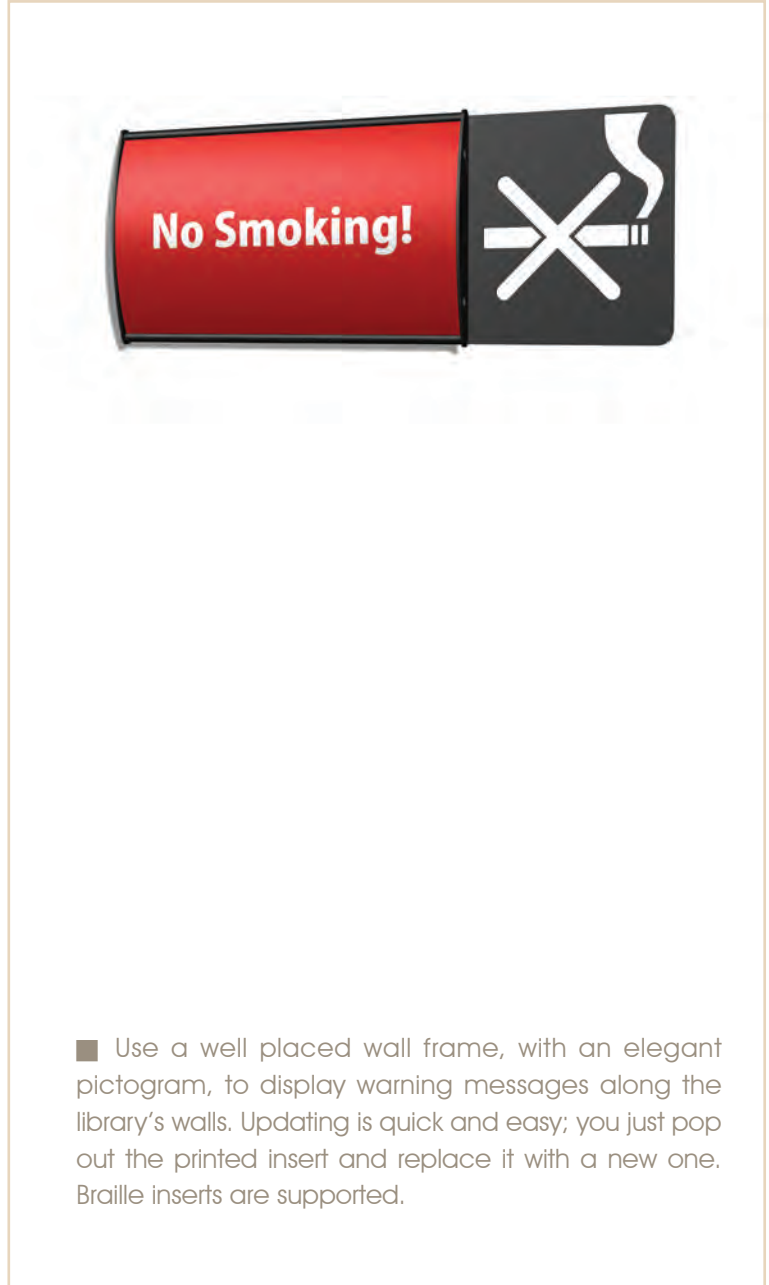

- Use a well placed wall frame, with an elegant pictogram, to display warning messages along the library's walls. Updating is quick and easy; you just pop out the printed insert and replace it with a new one. Braille inserts are supported.



Use of mobile phone is prohibited- Pictogram

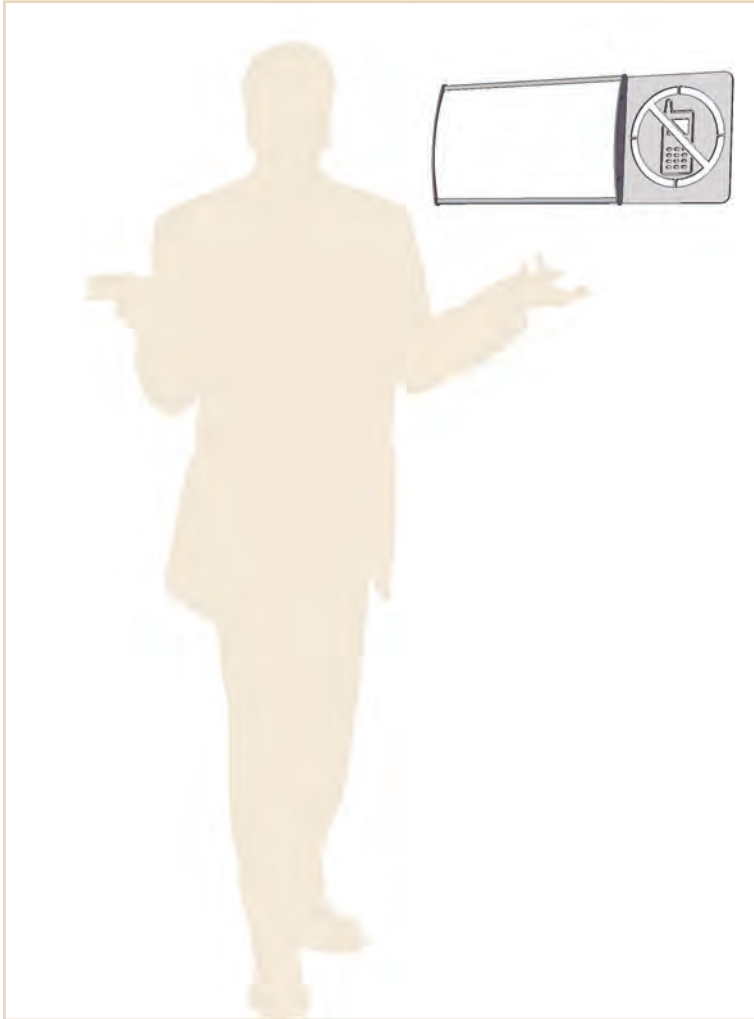

**Use of mobile phone is prohibited- Pictogram  
SECT0028**

Overall sign size: H 6" x W 15.15"  
H 153mm x W 385mm

Insert size: 5.83" x 9.84" (148mm x 250mm)

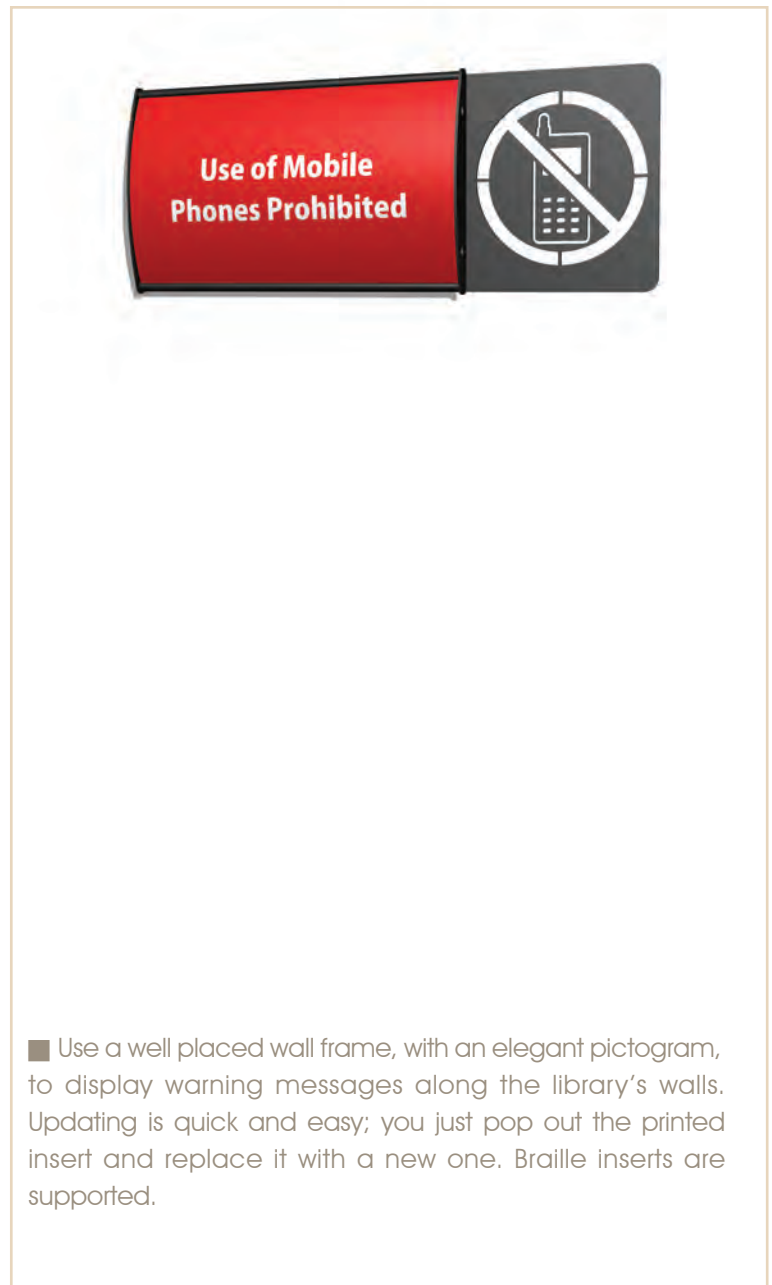

■ Use a well placed wall frame, with an elegant pictogram, to display warning messages along the library's walls. Updating is quick and easy; you just pop out the printed insert and replace it with a new one. Braille inserts are supported.



Eating is prohibited pictogram

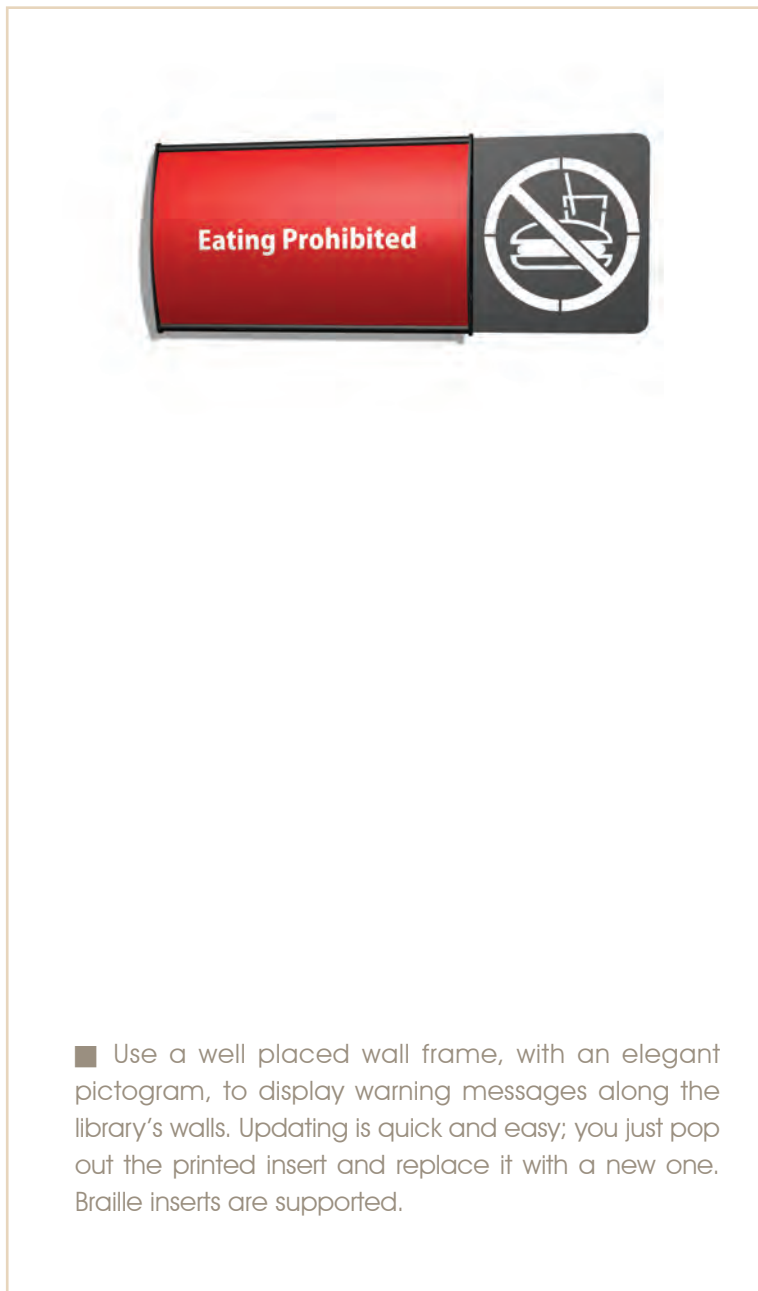
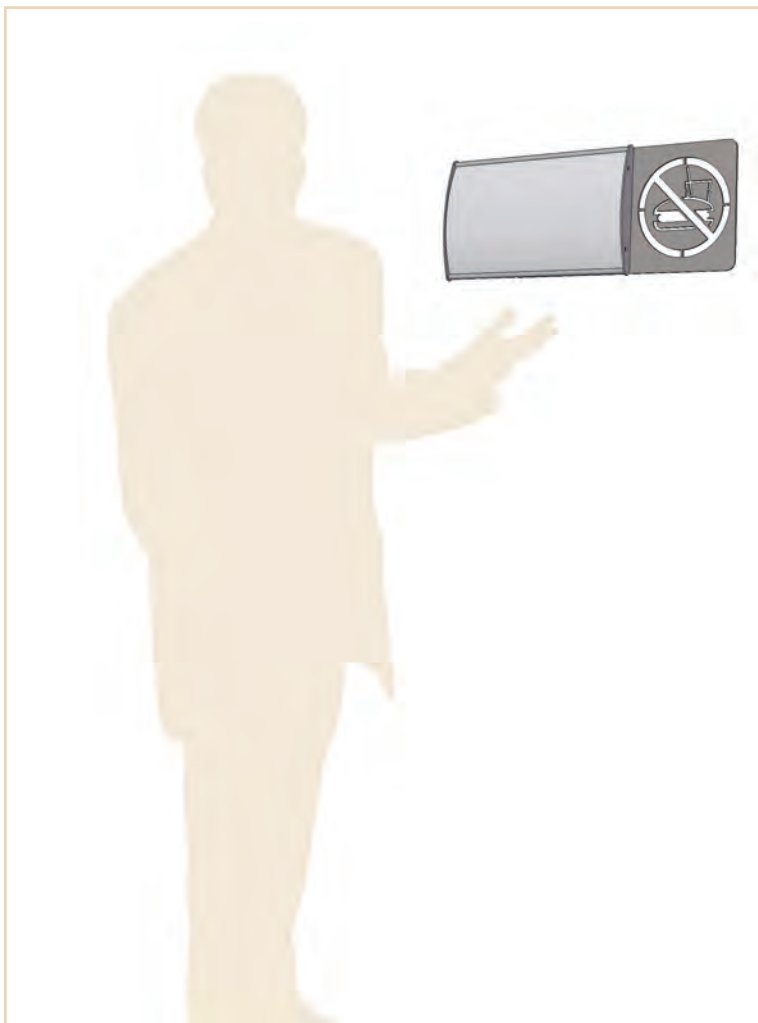

### Eating is prohibited pictogram

#### SECT0029

Overall sign size: H 6" x W 15.15"  
H 153mm x W 385mm

Insert size: 5.83" x 9.84" (148mm x 250mm)

- Use a well placed wall frame, with an elegant pictogram, to display warning messages along the library's walls. Updating is quick and easy; you just pop out the printed insert and replace it with a new one. Braille inserts are supported.



Please keep quiet- Pictogram

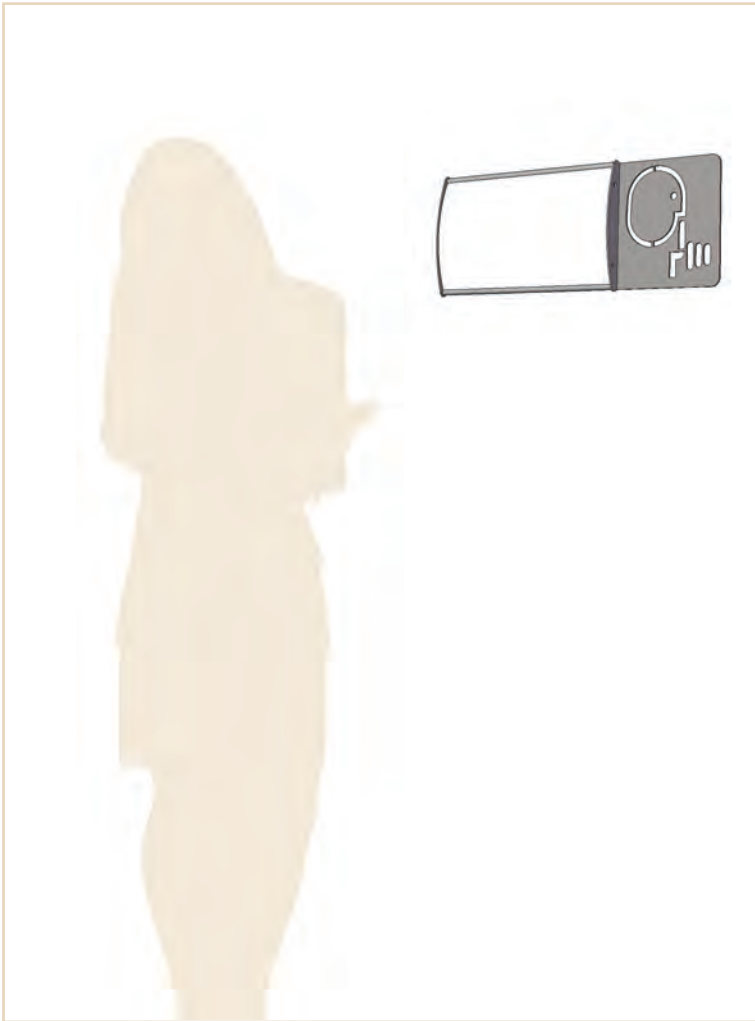

**Please keep quiet- Pictogram**  
**SECT0030**

Overall sign size: H 6" x W 15.15"  
H 153mm x W 385mm

Insert size: 5.83" x 9.84" (148mm x 250mm)

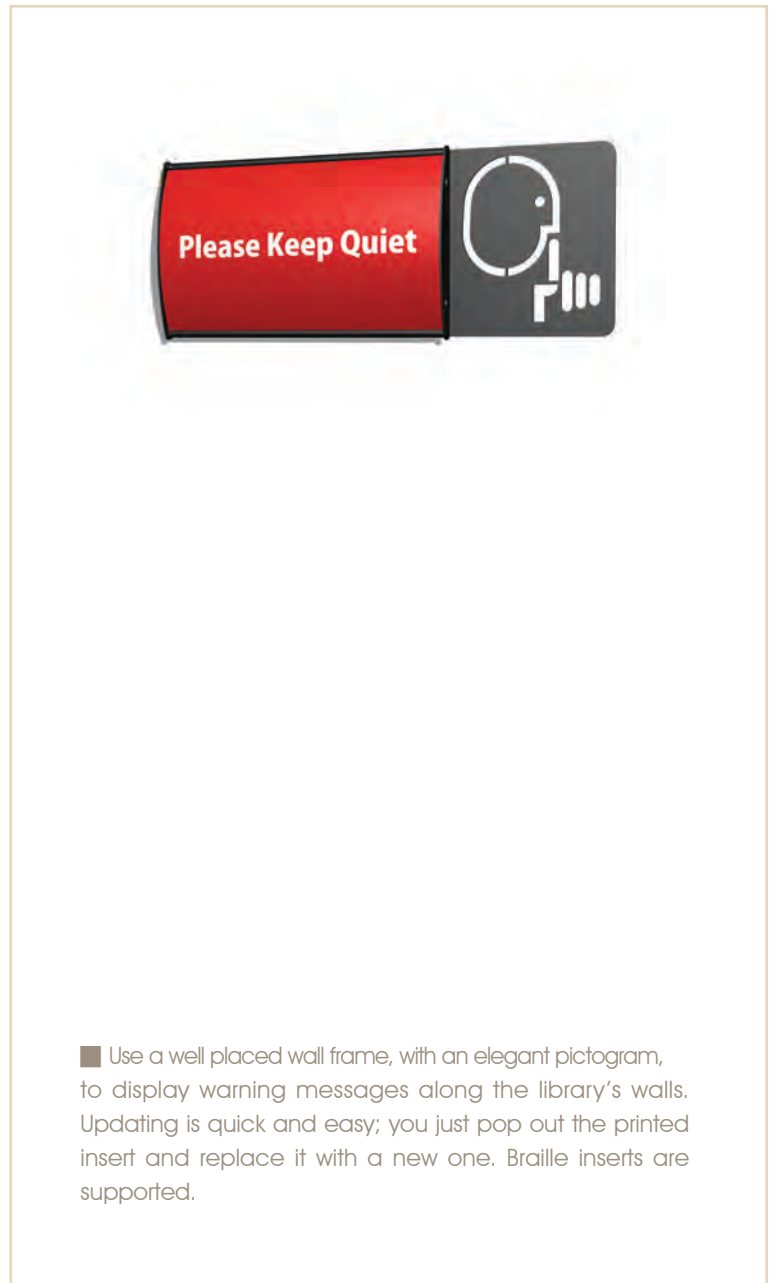

■ Use a well placed wall frame, with an elegant pictogram, to display warning messages along the library's walls. Updating is quick and easy; you just pop out the printed insert and replace it with a new one. Braille inserts are supported.



No entry for pets



**No entry for pets**

**SECT0031**

Overall sign size: H 6" x W 15.15"  
H 153mm W 385mm

Insert size: 5.83" x 9.84" (148mm x 250mm)

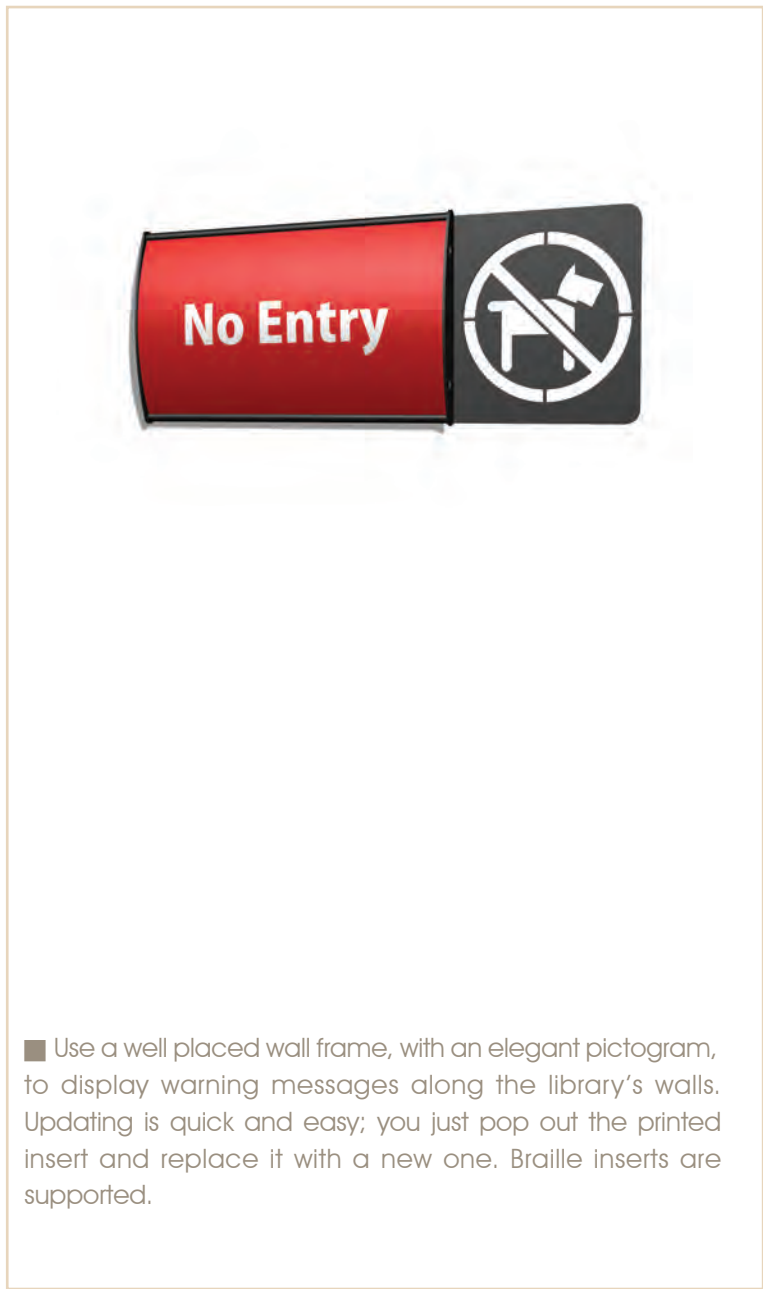

■ Use a well placed wall frame, with an elegant pictogram, to display warning messages along the library's walls. Updating is quick and easy; you just pop out the printed insert and replace it with a new one. Braille inserts are supported.



No pets are allowed

## Warning Signs

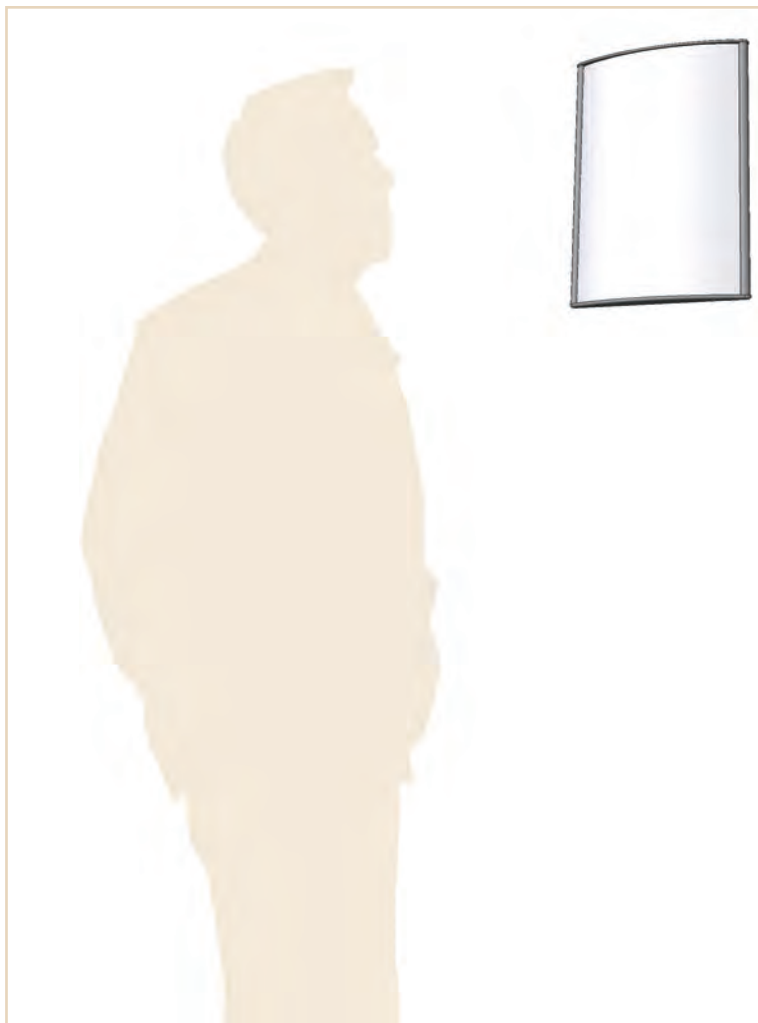

**No pets are allowed**

**WFP33**

Overall sign size: H 8" x W 7.2"  
H 205mm W 182.7mm

Insert size: 7.87" x 5.83" (200mm x 148mm)



■ Use a well placed wall frame to display warning messages along the library's walls. Updating is quick and easy; you just pop out the printed insert and replace it with a new one. Braille inserts are supported.

Vista System strive to continually provide an "Unbelievable & Incredible" experience to our customers with everything we do.

## Emergency signs

Emergency signs are used for directing visitors out of the library or to special facilities within the library in case of an emergency. Vista System offers a wide selection of eye catching signs for displaying emergency signs within the library.

Choose the right product for you and order today from your preferred Vista System sign dealer.





Emergency Exit

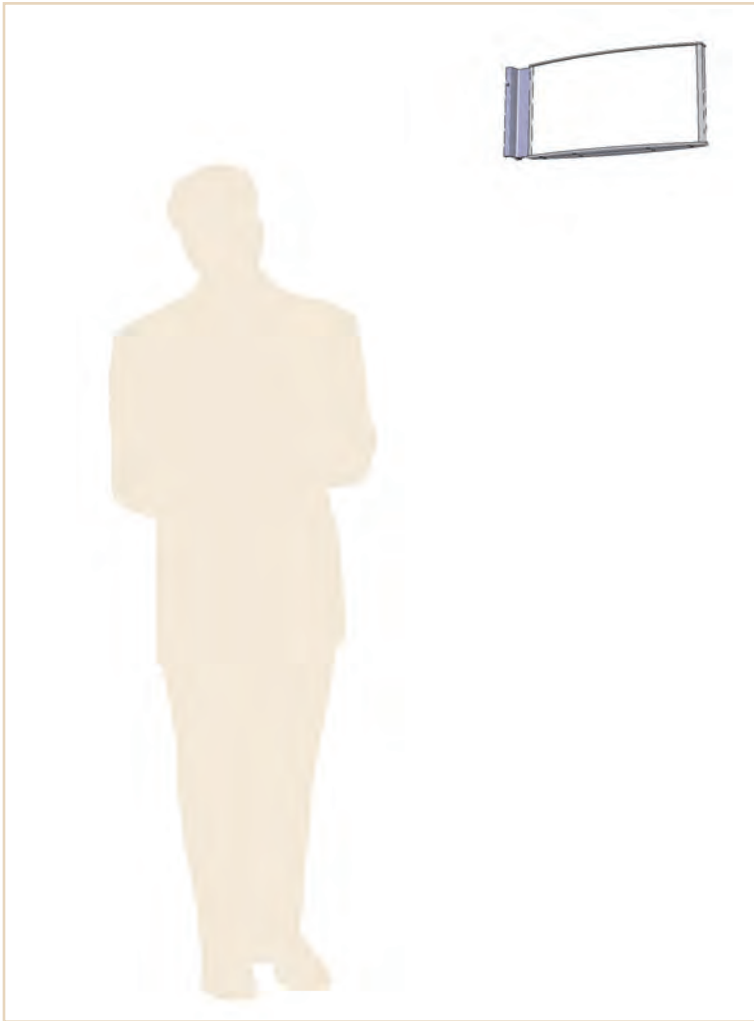

## Emergency Exit

### SECT0073

Overall sign size: H 13.3" x W 6.14"  
H 337.6mm x 156mm

Insert size: 11.7" x 5.9" (297.4mm x 150mm)



- Use a well placed flag sign to display the library emergency signs. Updating is quick and easy; you just pop out the printed insert and replace it with a new one. Braille inserts are supported.



Emergency Exit



## Emergency Exit

### SECT0074

Overall sign size: H 5.3" x W 12.4"  
H 135mm x W 314.6mm

Insert size: 5.11" x 10" (130mm x 254mm)

■ Suspended illuminated signs can be easily seen from a distance and, thus, are ideal for displaying the emergency exit. Suspended signs are very versatile; they come in many sizes and types and can be easily mounted to the ceiling. Updating is quick and easy: just remove the printed insert and replace it with a new one. Braille inserts are supported.



Fire Extinguisher

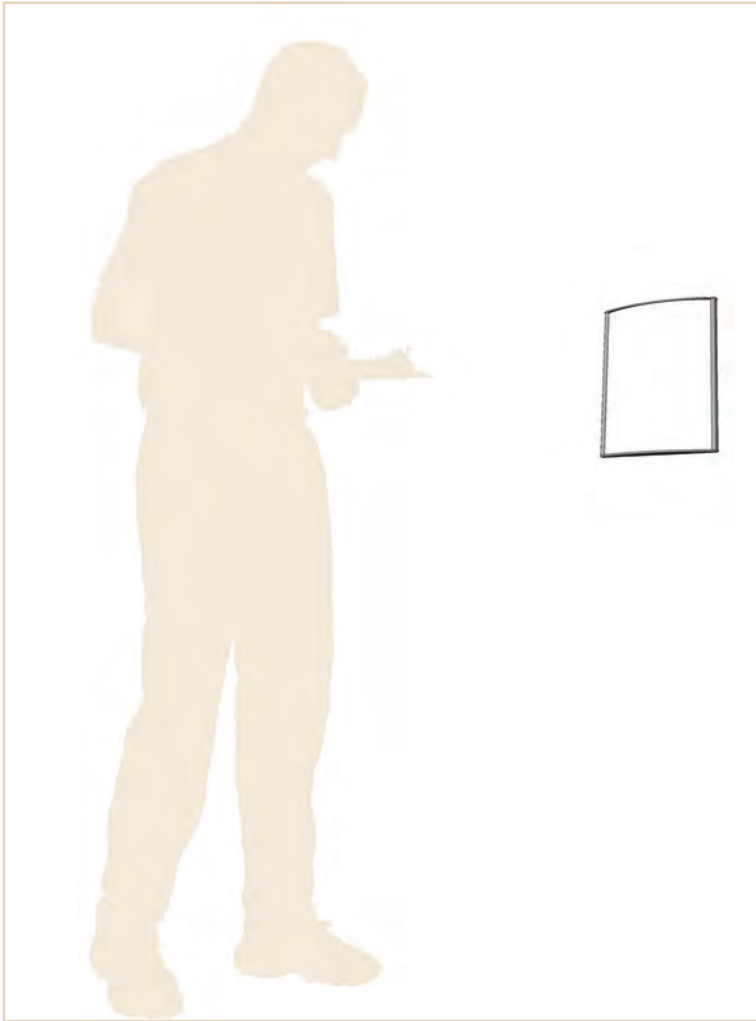

## Fire Extinguisher

### WFP33

Overall sign size: H 8" x W 6"  
H 205mm x W 151mm

Insert size: 7.87" x 5.83" (200mm x 148mm)

■ Use a well placed wall frame to display the fire extinguisher locations around the library. Updating is quick and easy; just remove the printed insert and replace it with a new one. Braille inserts are supported.

The system is designed to handle most applications and materials used in the sign industry. Any material with flexibility and the correct thickness may be used as an insert with Vista System frames.

## Toilet Signs

Toilet signs are used for directing visitors to the restrooms of the library. Vista System offers a wide selection of eye catching signs for identifying toilets within the library.

Choose the right product for you and order today from your preferred Vista system sign dealer.





Restrooms pictogram

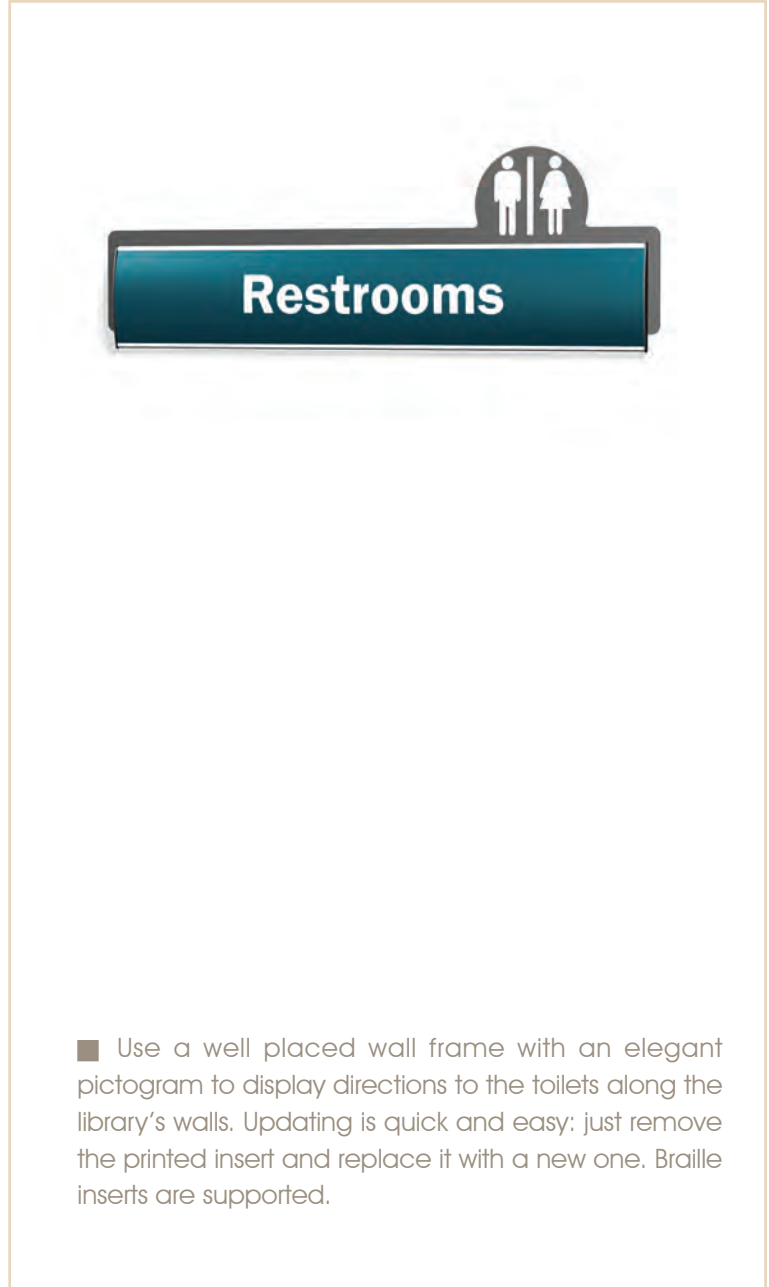
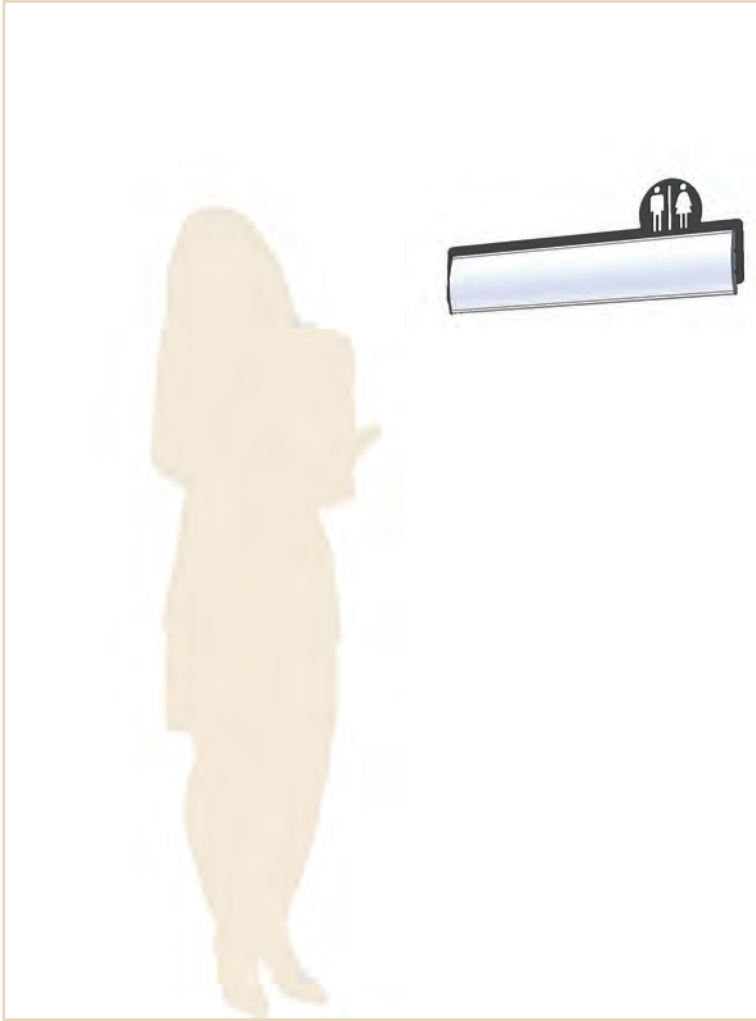

### Restrooms pictogram

#### SECT0026

Overall sign size: H 9.12" x W 26"  
H 231.6mm x W 660.8mm

Insert size: 4.65" x 24.8" (118mm x 630mm)

- Use a well placed wall frame with an elegant pictogram to display directions to the toilets along the library's walls. Updating is quick and easy: just remove the printed insert and replace it with a new one. Braille inserts are supported.



Ladies' room

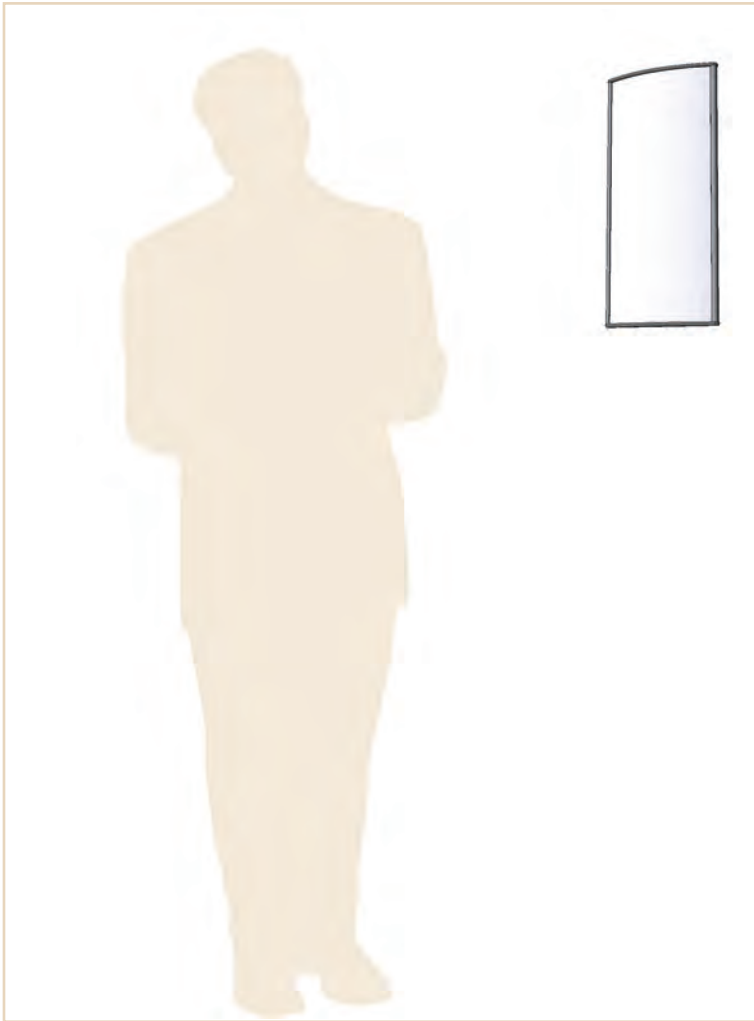

### Ladies' room

#### WFP9

Overall sign size: H 7.87" x W 4"  
H 200mm x W 102mm

Insert size: 7.87" x 3.83" (200mm x 97.5mm)



■ Use a well placed wall frame on the wall or on the restroom door to identify the restrooms. Updating is quick and easy: just remove the printed insert and replace it with a new one. Braille inserts are supported.



Men's room

## Toilet Signs

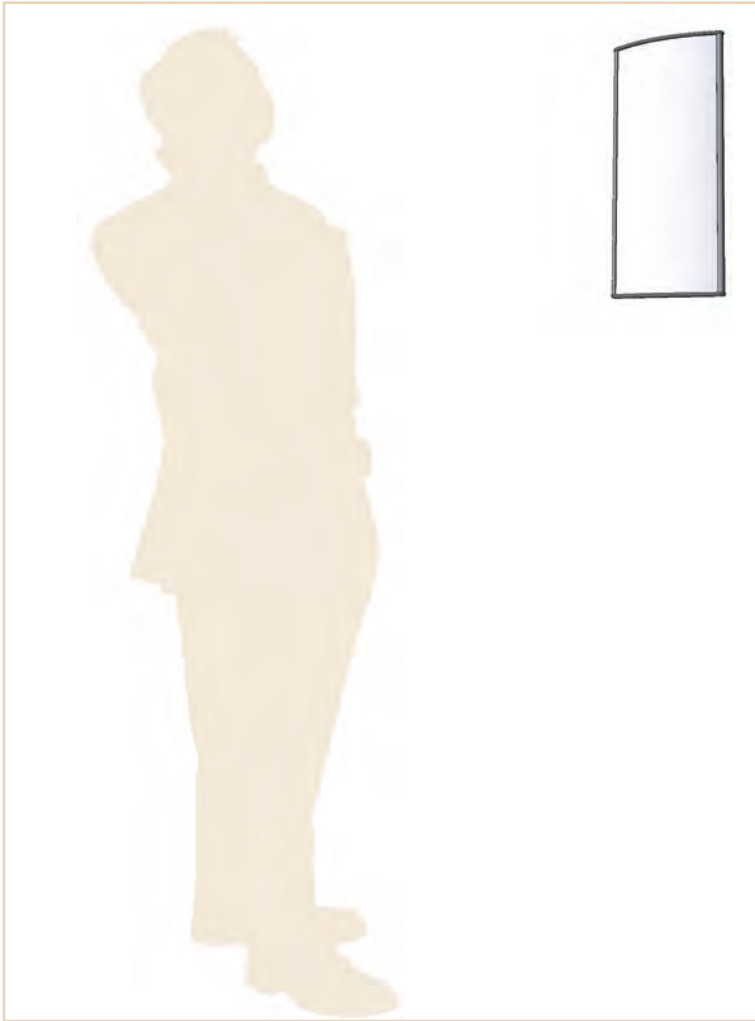

### Men's room

#### WFP9

Overall sign size: H 7.87" x W 4"  
H 200mm x W 102mm

Insert size: 7.87" x 3.84" (200mm x 97.5mm)

- Use a well placed wall frame on the wall or on the restroom door to identify the restrooms. Updating is quick and easy; just remove the printed insert and replace it with a new one. Braille inserts are supported.

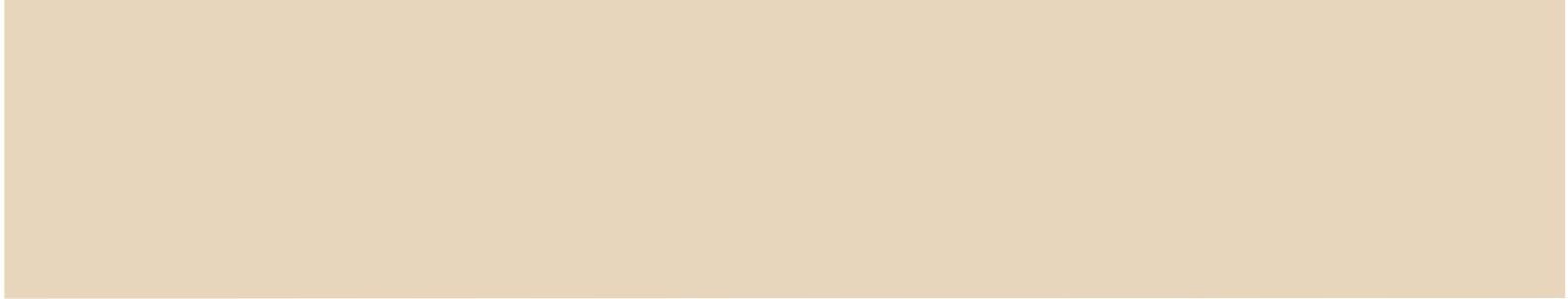

Disabled restrooms (Braille)

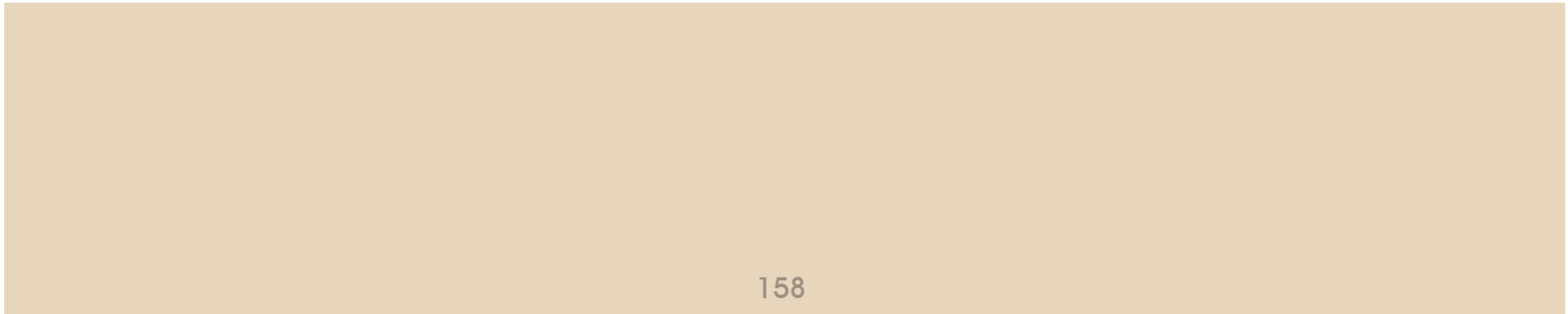

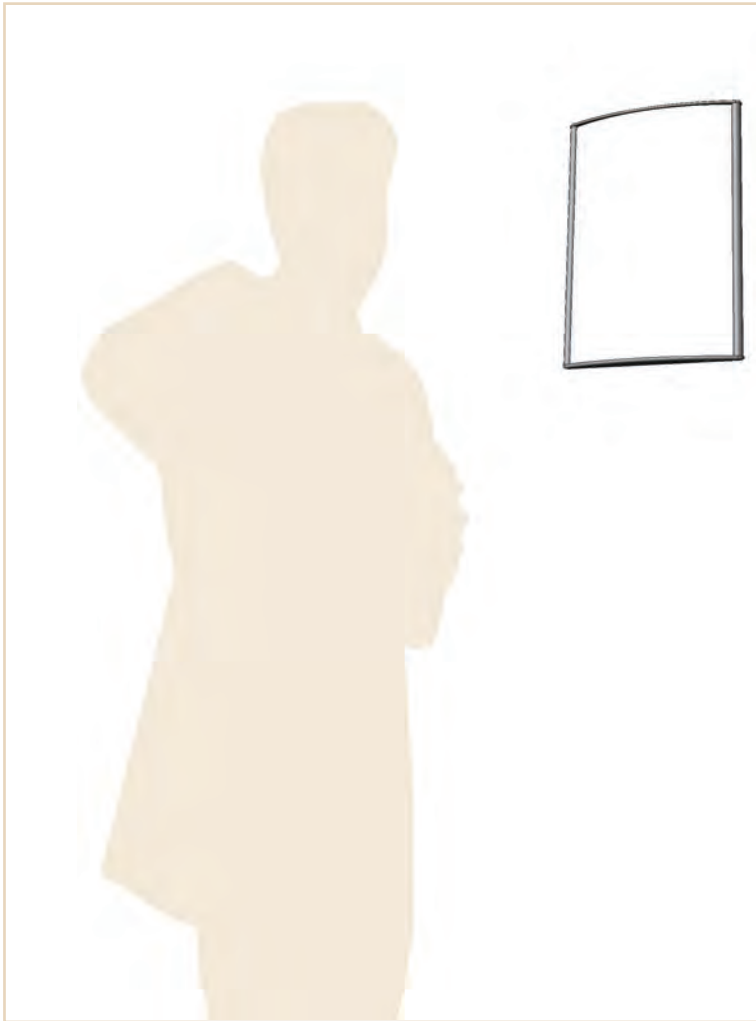

### Disabled restrooms (Braille)

#### WDP33

Overall sign size: H 7.87" x W 6"  
H 200mm x W 153mm

Insert size: 5.82" x 7.87" (148mm x 200mm)



■ Use a well placed wall frame on the wall or on the restroom door to identify the restrooms. Updating is quick and easy: just remove the printed insert and replace it with a new one. Braille inserts are supported.



Men's room (Braille)

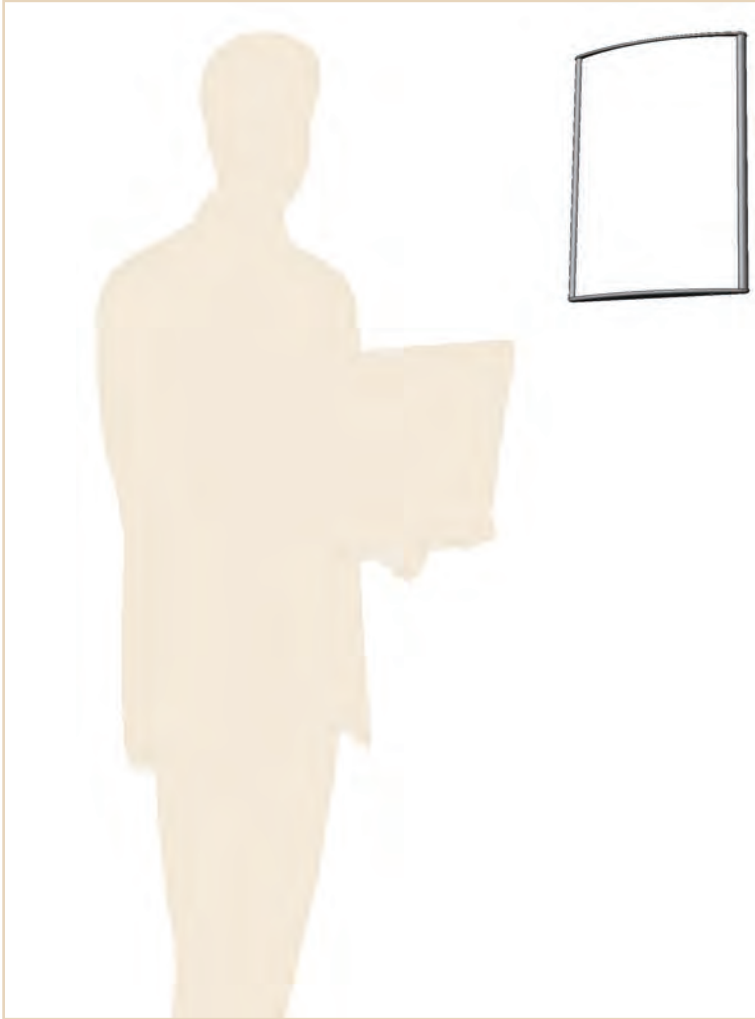

### Men's room (Braille)

#### WDP33

Overall sign size: H 7.87" x W 6"  
H 200mm x W 153mm

Insert size: 5.82" x 7.87" (148mm x 200m)

- Use a well placed wall frame on the wall or on the restroom door to identify the restrooms. Updating is quick and easy: just remove the printed insert and replace it with a new one. Braille inserts are supported.

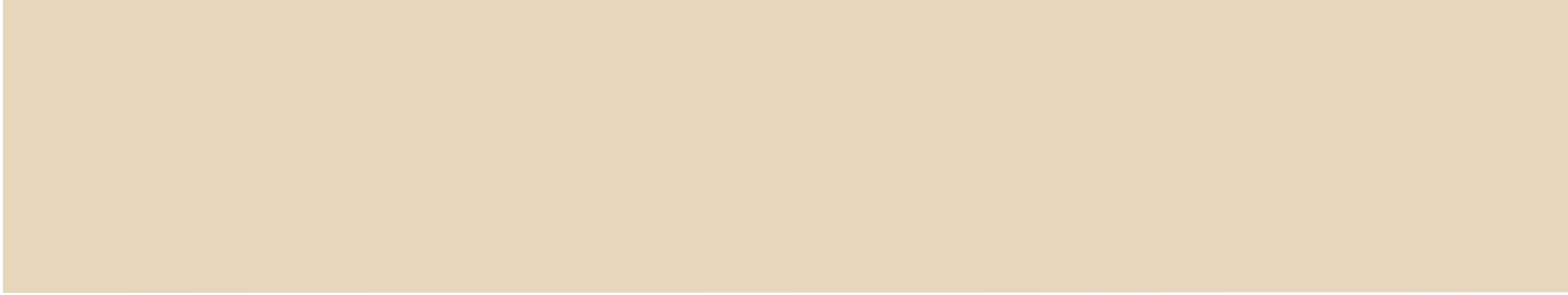

Restrooms

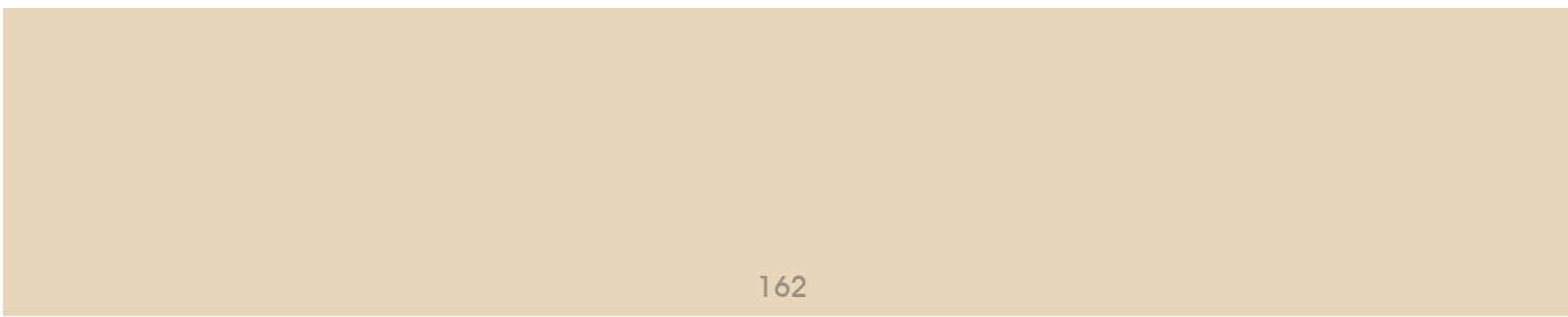

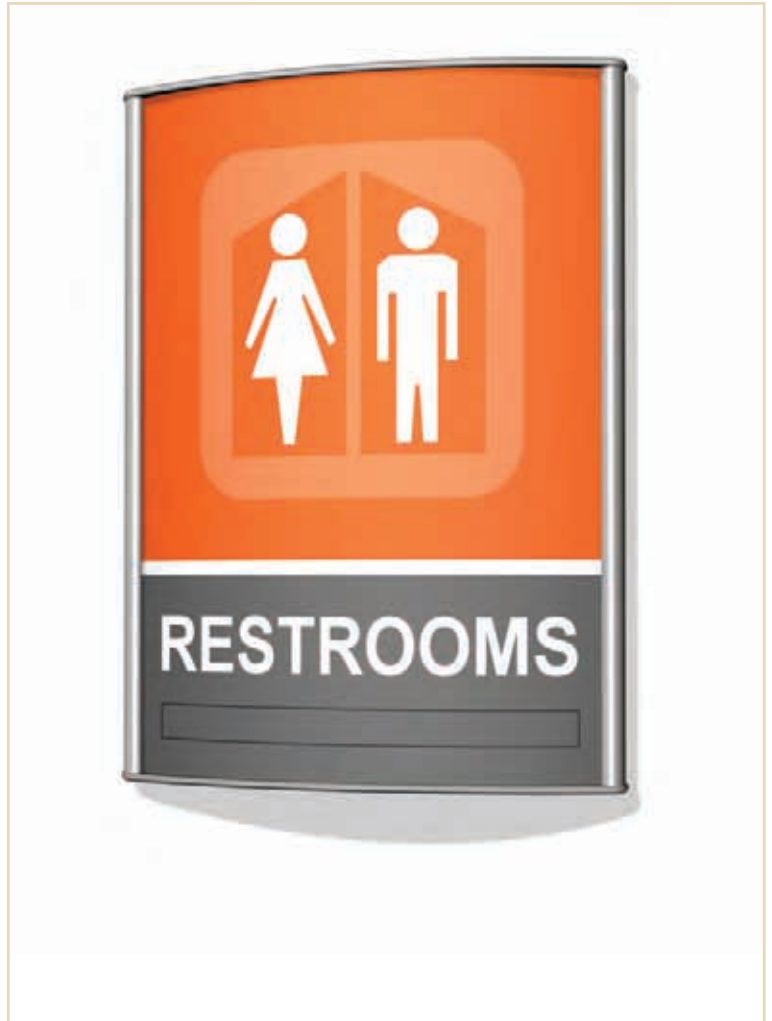
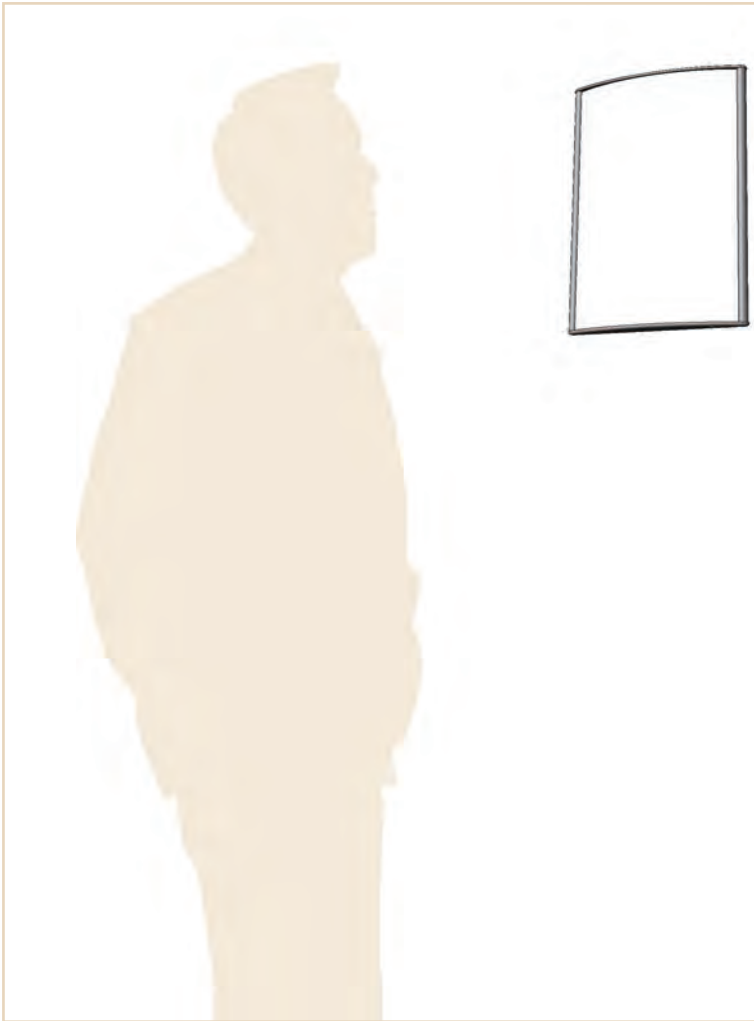

## Restrooms

### WDP33

Overall sign size: H 7.87" x W 6"  
H 200mm x W 153mm

Insert size: 5.82" x 7.87" (148mm x 200m)

■ Use a well placed wall frame on the wall or on the restroom door to identify the restrooms. Updating is quick and easy: just remove the printed insert and replace it with a new one. Braille inserts are supported.

A wide choice of sizes and shapes allows the customer to stick to one sign system throughout a project, and to find solutions to almost any kind of sign required.

# Computers and Internet

In today's modern libraries, computer and internet services are among the most important facilities a library should offer, from printing services to disk burning and web surfing terminals. Visitors should be able to clearly identify these services. Vista System offers a wide selection of sign types for the library's computer and internet facilities.

Choose the right product for you and order today from your preferred Vista system sign dealer.



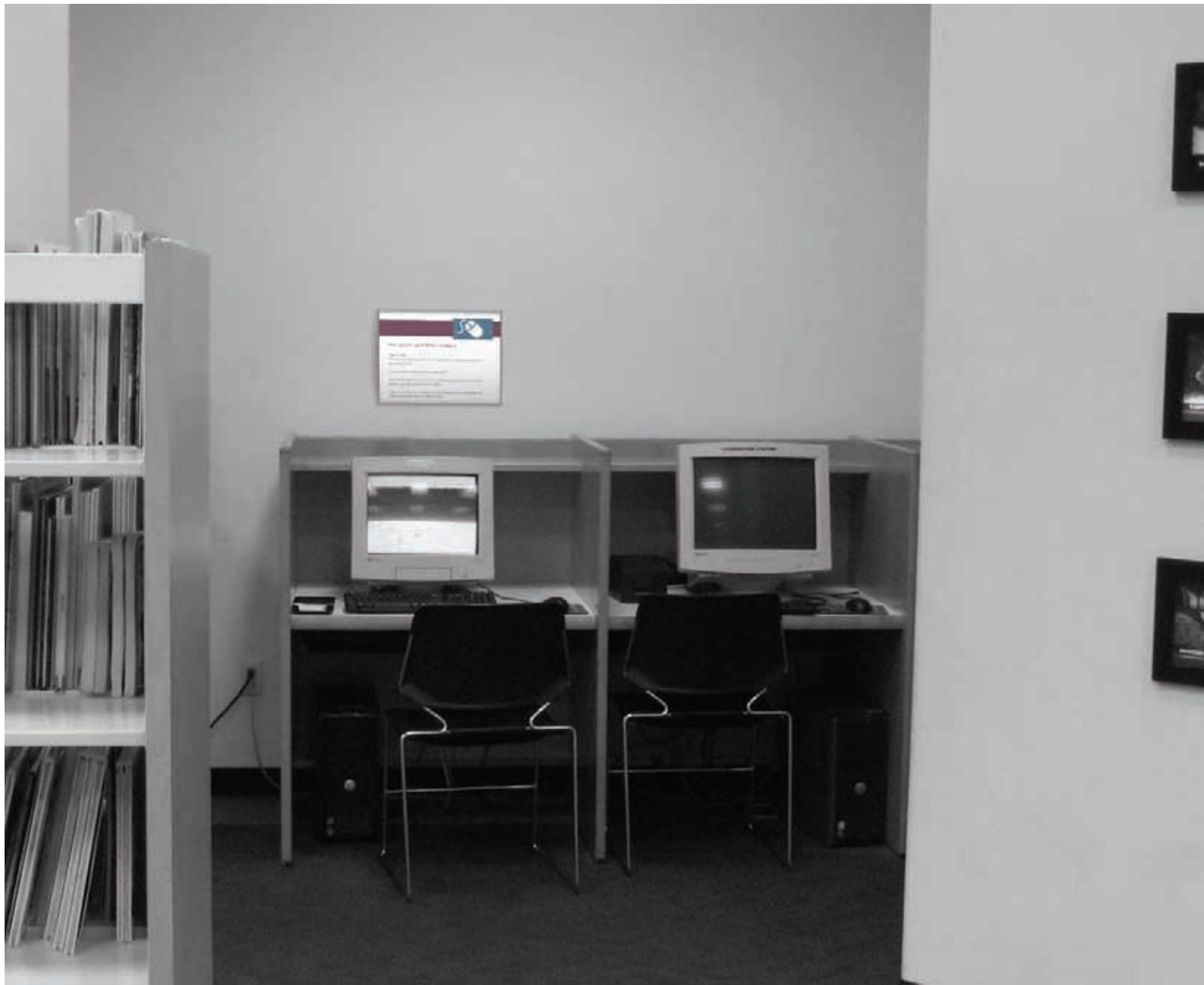

Instructions for computer

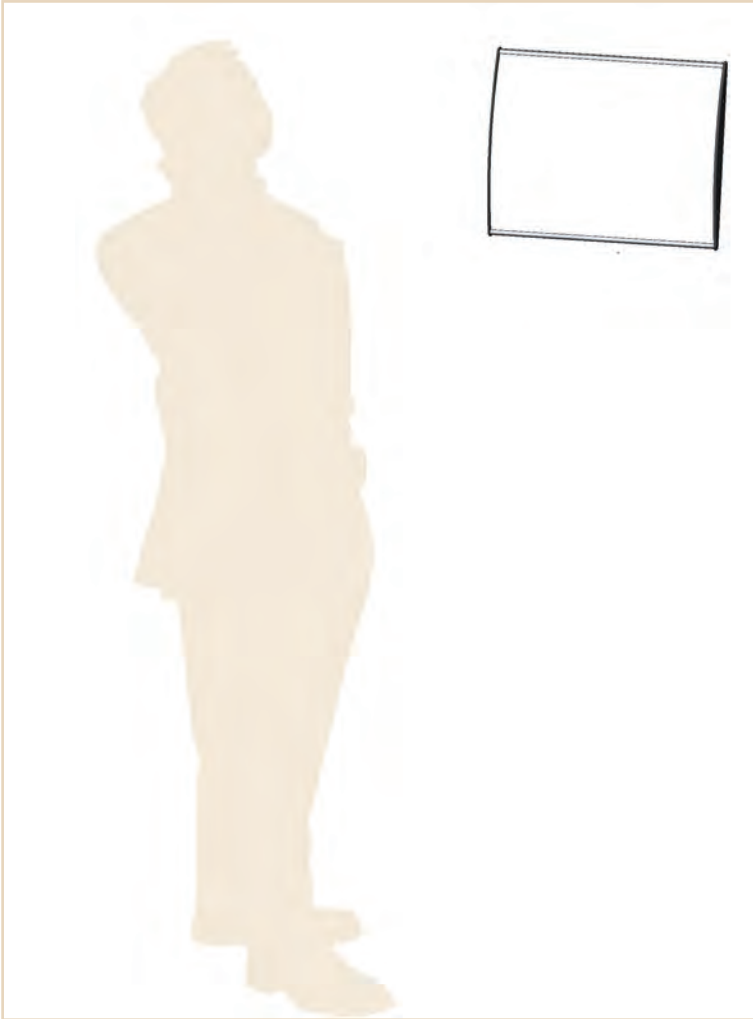

**Instructions for computer use**

**WFL50**

Overall sign size: H 8.8" x W 11"  
 H 223mm x W 283.4mm

Insert size: 8.54" x 11" (217mm x 279.4mm)

■ Use a well placed wall frame for displaying instructions for computer use around the computers facilities. Updating is quick and easy; you just pop out the printed insert and replace it with a new one. Braille inserts are supported.



Wireless Internet connecting instructions

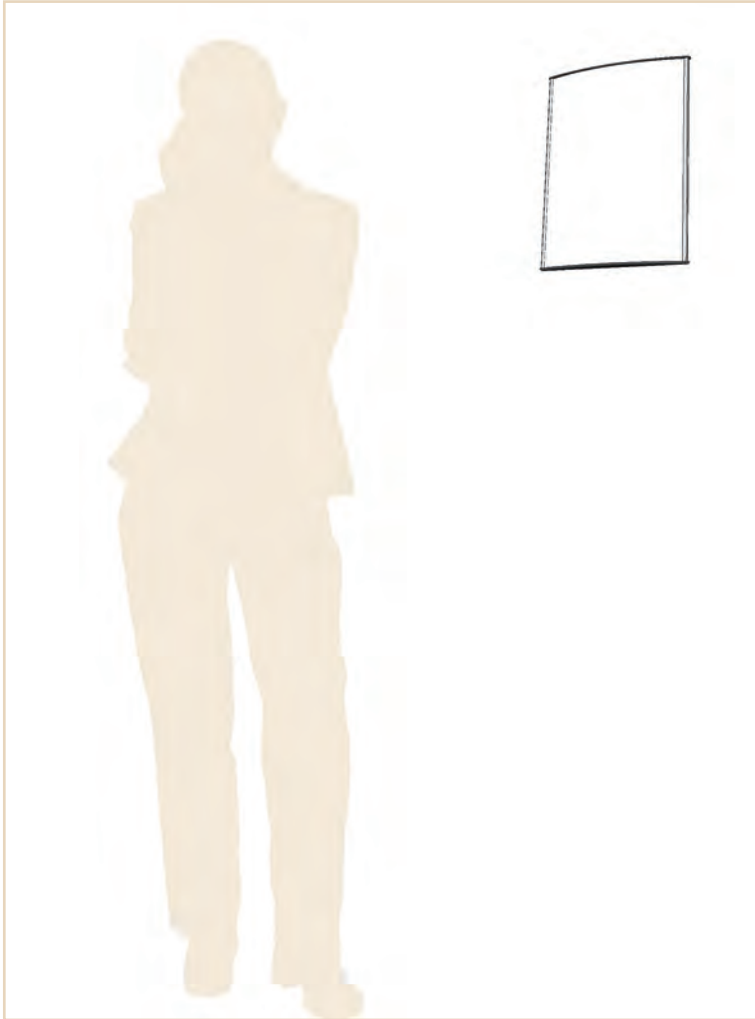

## Wireless Internet connecting instructions

### WFL50

Overall sign size: H 11" x W 8.8"  
H 283.4mm x W 223mm

Insert size: 11" x 8.54" (279.4mm x 217mm)



■ Use a well placed wall frame for displaying Wireless Internet connecting instructions around the internet facilities. Updating is quick and easy; you just pop out the printed insert and replace it with a new one. Braille inserts are supported.



Internet use procedure

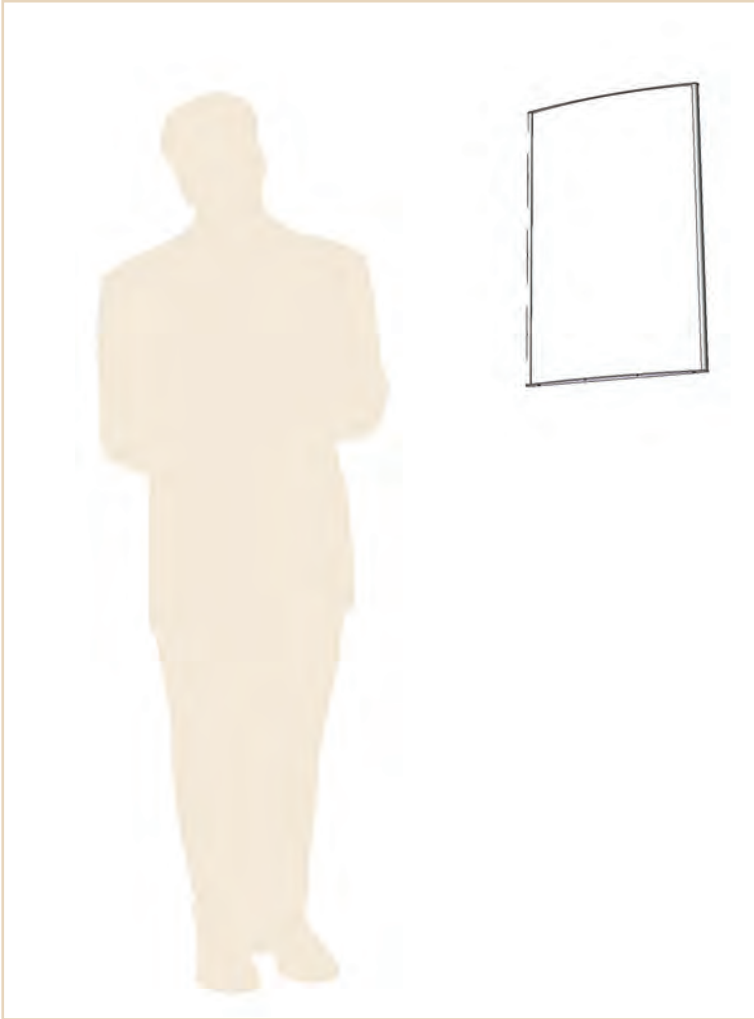

**Internet use procedure**

**SECT0066**

Overall sign size: H 24.4" x W16"  
 H 620mm x W 405mm

Insert size: 24.25" x 15.75" (616mm x 400mm)

■ Use a well placed wall frame for displaying Internet use procedure around the internet facilities. Updating is quick and easy; you just pop out the printed insert and replace it with a new one. Braille inserts are supported.



Scanner use instructions

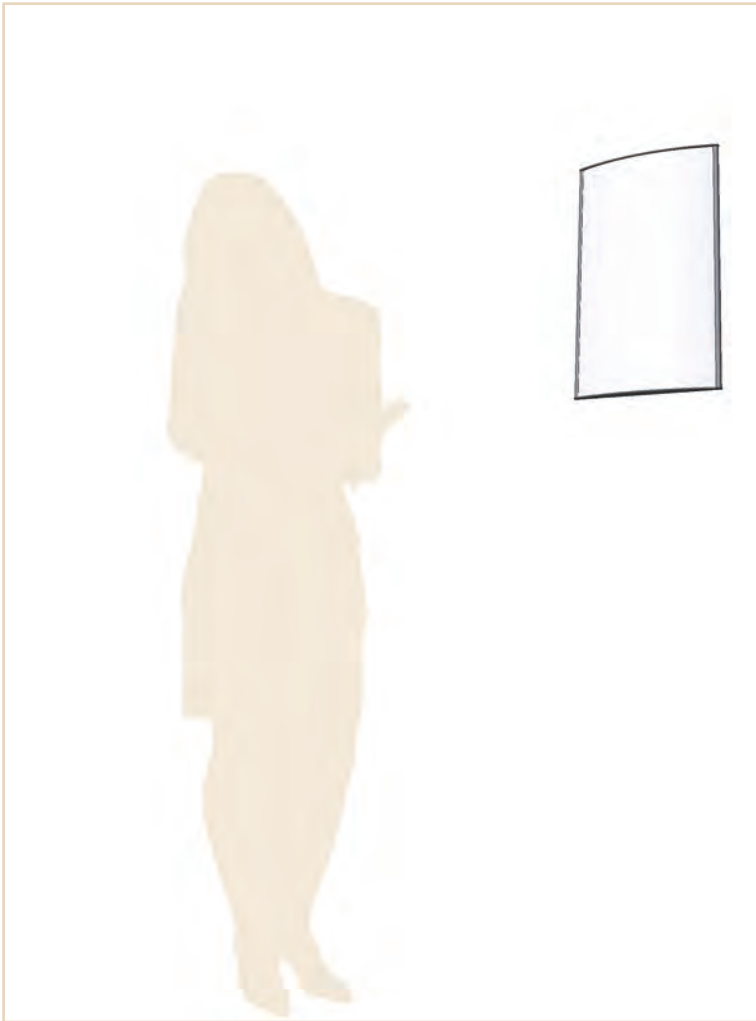

**Scanner use instructions**

**WFP168**

Overall sign size: H 17.2" x W 11.22"  
H 436mm x W 285mm

Insert size: 17" x 10.98" (431.8mm x 279mm)



■ Use a well placed wall frame for displaying Scanner use instructions around the computers facilities. Updating is quick and easy; you just pop out the printed insert and replace it with a new one. Braille inserts are supported.



Photocopier use instructions

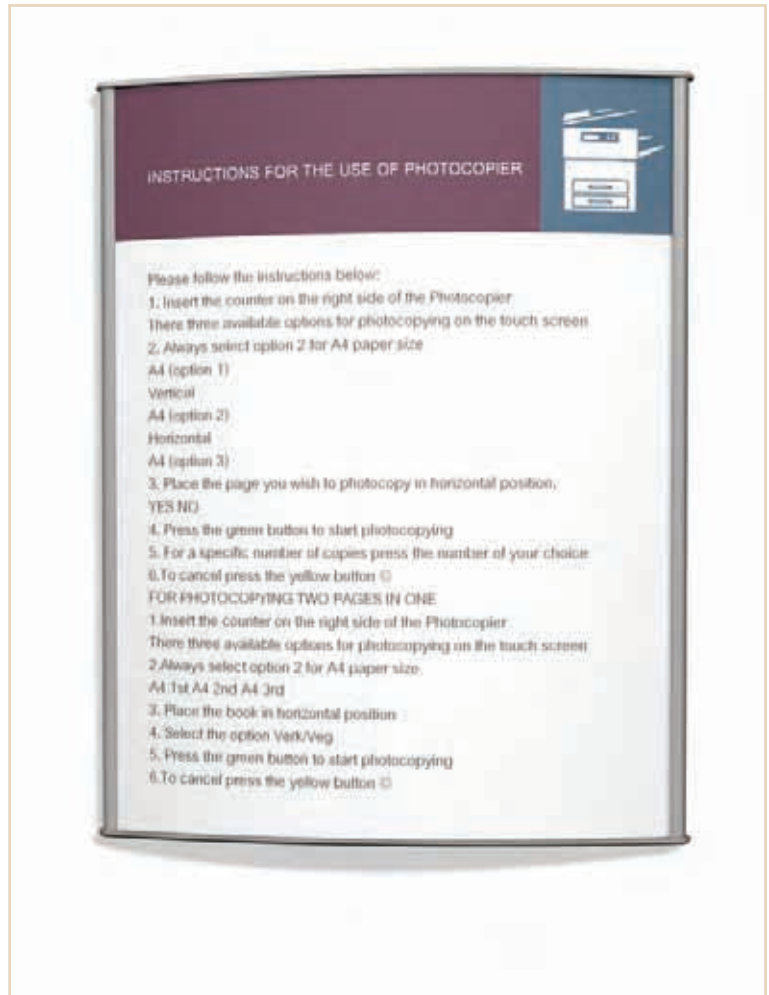
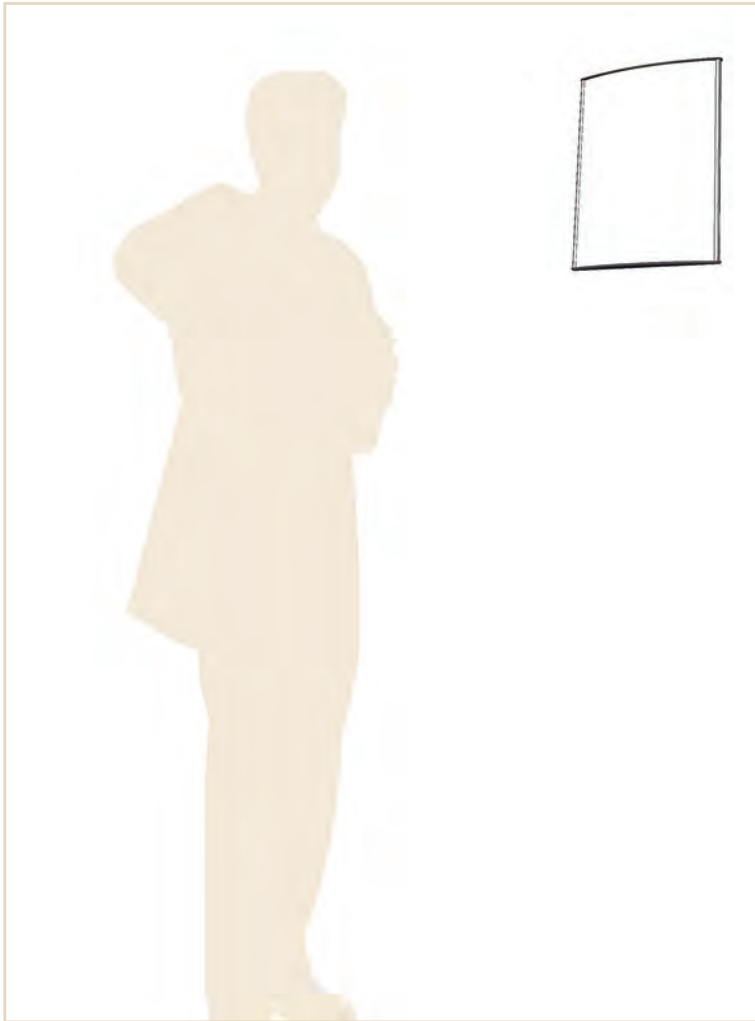

## Photocopier use instructions

### WFP84

Overall sign size: H 11" x W 8.8"  
H 283.4mm x W 223mm

Insert size: 11" 8.54" (279.4mm x 217mm)

■ Use a well placed wall frame for displaying Photocopier use instructions around the computers facilities. Updating is quick and easy; you just pop out the printed insert and replace it with a new one. Braille inserts are supported.



Copyright protection

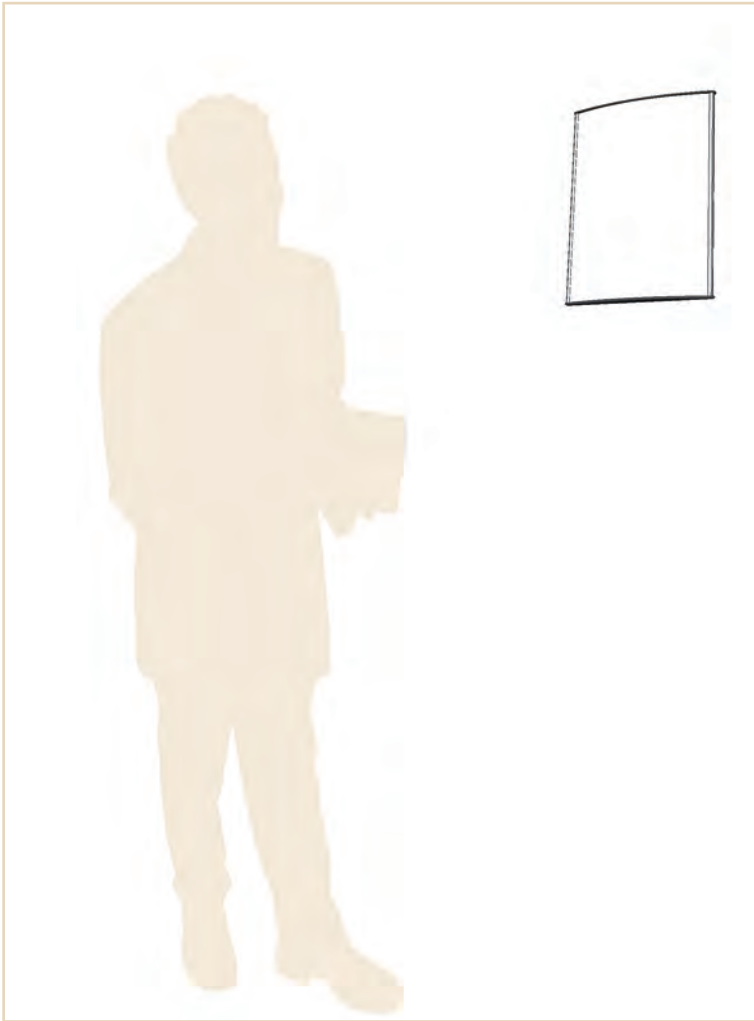

## Copyright protection

### WFP84

Overall sign size: H 11" x W 8.8"  
H 283.4 mm x W 223 mm

Insert size: 11" x 8.54" (279.4 mm x 217 mm)

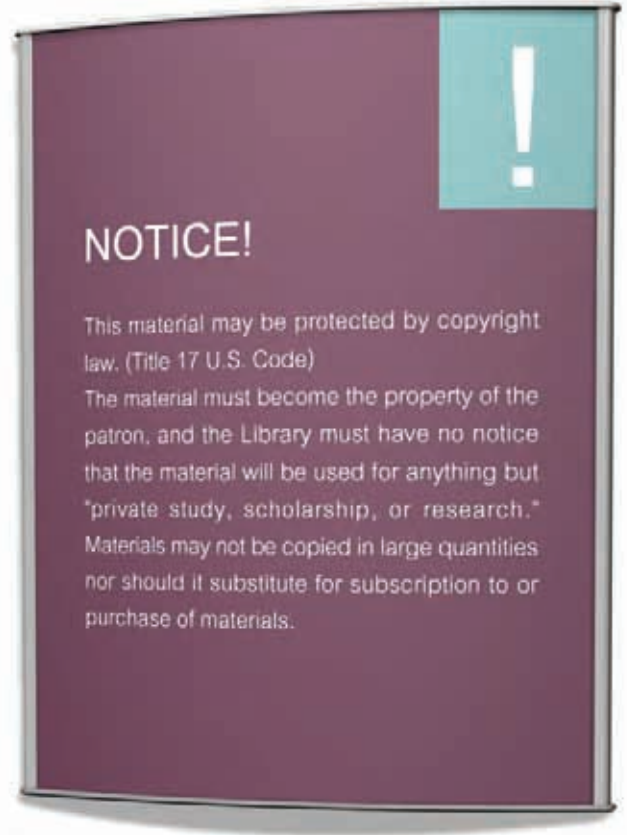

- Use a well placed wall frame for displaying Copyright protection notice around the computers facilities. Updating is quick and easy; you just pop out the printed insert and replace it with a new one. Braille inserts are supported.

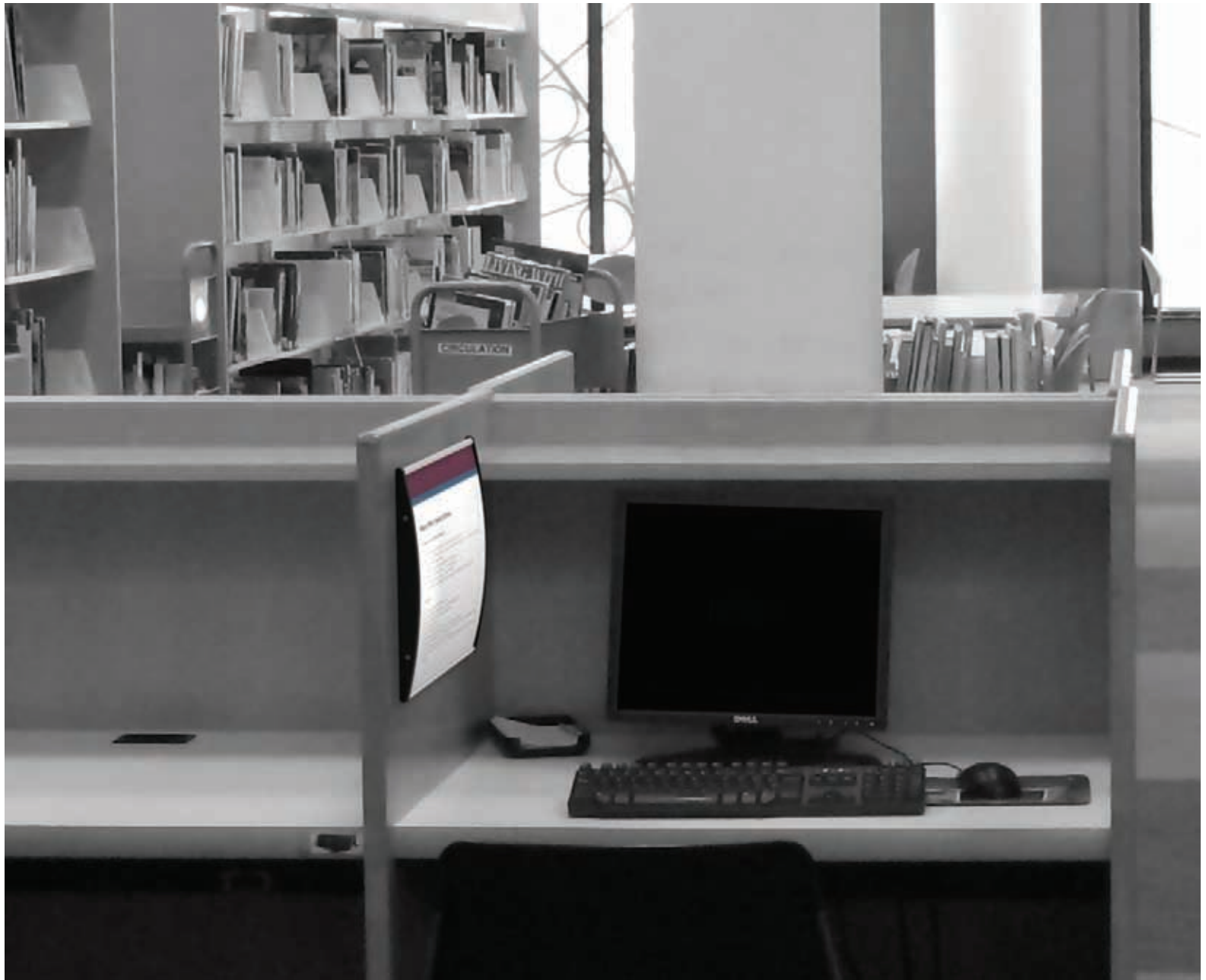

Microfilm instructions

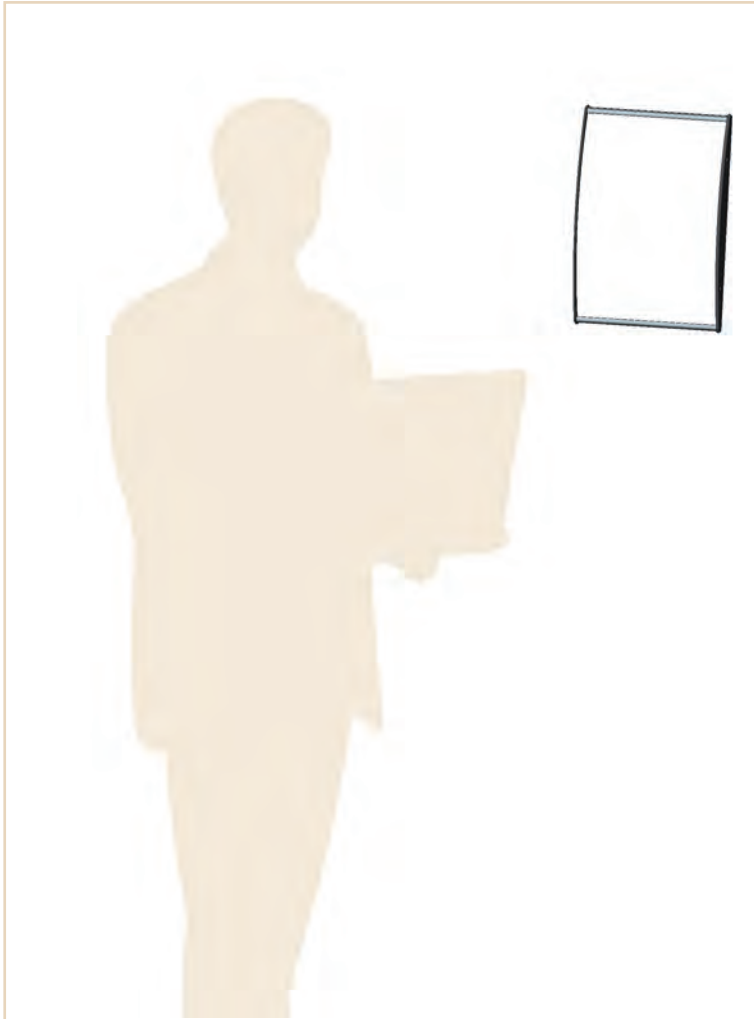

## Microfilm instructions

### SECT0068

Overall sign size: H 8.8" x W 6"  
H 223mm x W 154mm

Insert size: 8.54" x 5.9" (217mm x 150mm)

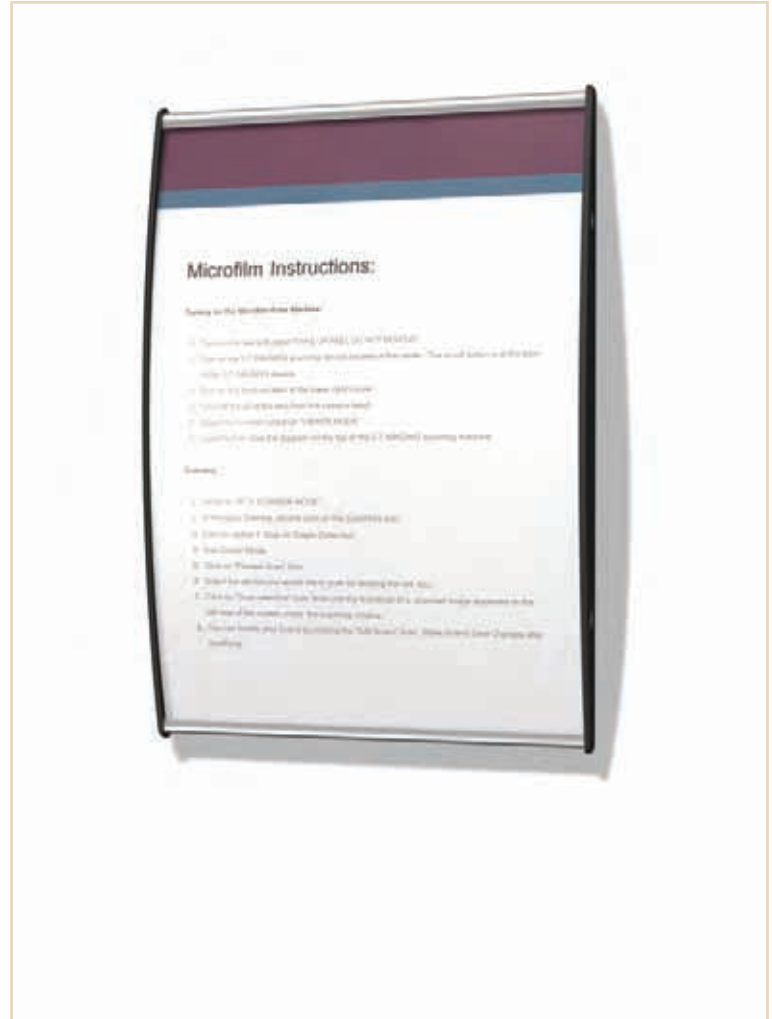

■ Use a well placed wall frame for displaying Microfilm instructions near the relevant facilities. Updating is quick and easy; you just pop out the printed insert and replace it with a new one. Braille inserts are supported.



Photocopying rates

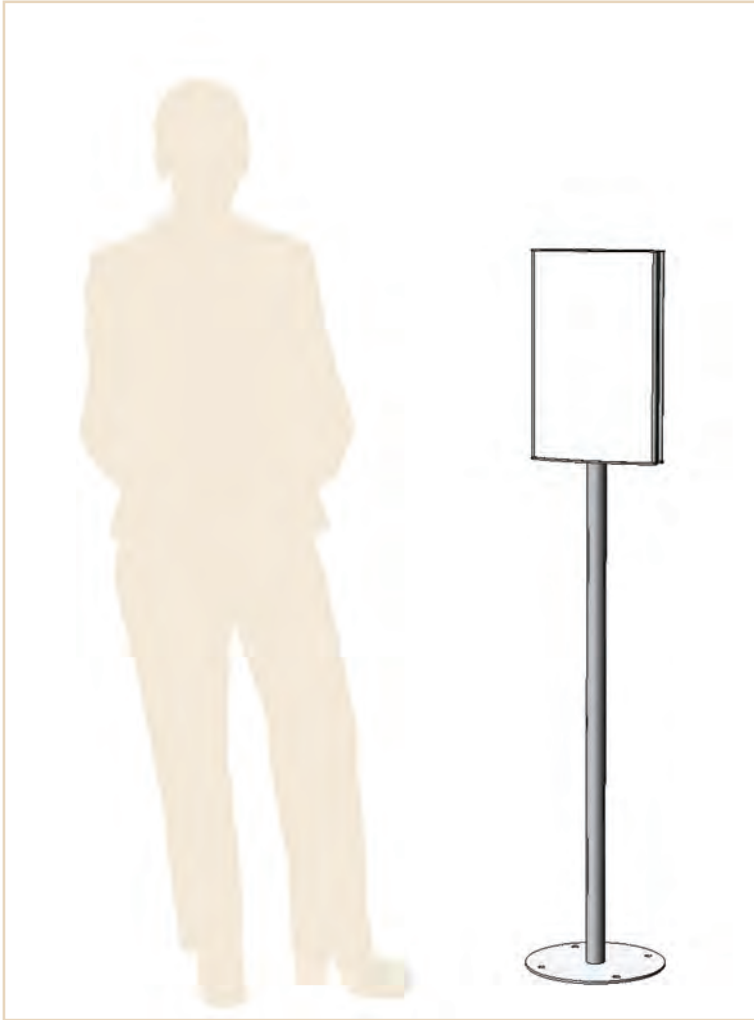

## Photocopying rates

### SECT0067

Overall sign size: H 60" x W 11.2"  
H 1524 mm x W 284.6 mm

Insert size: 17" x 10.98" (431.8 mm x 279 mm)

- Use a well placed post sign for displaying photocopying rates near the relevant facilities. Updating is quick and easy: just remove the printed insert and replace it with a new one. Braille inserts are supported.

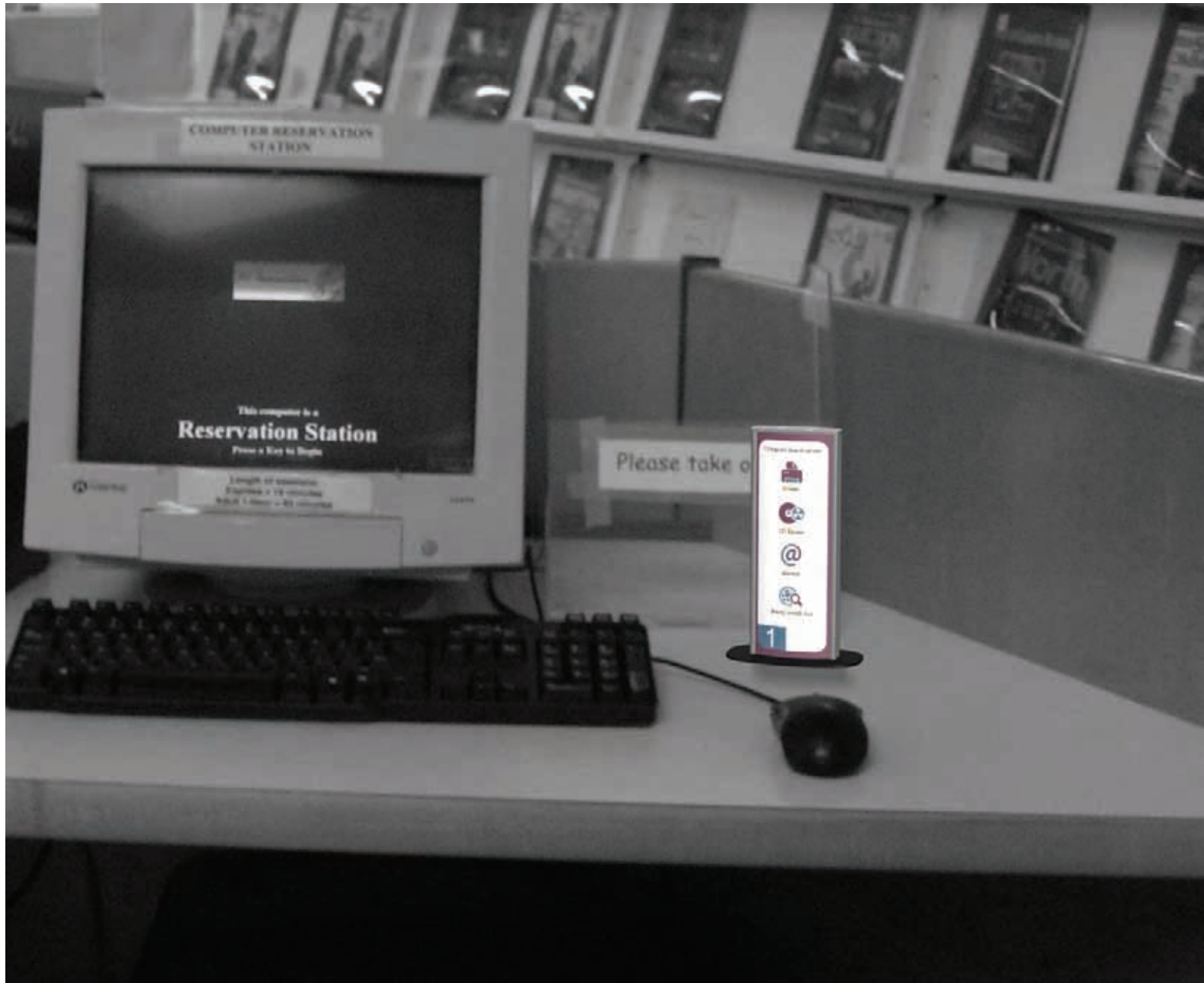

Computer specifications

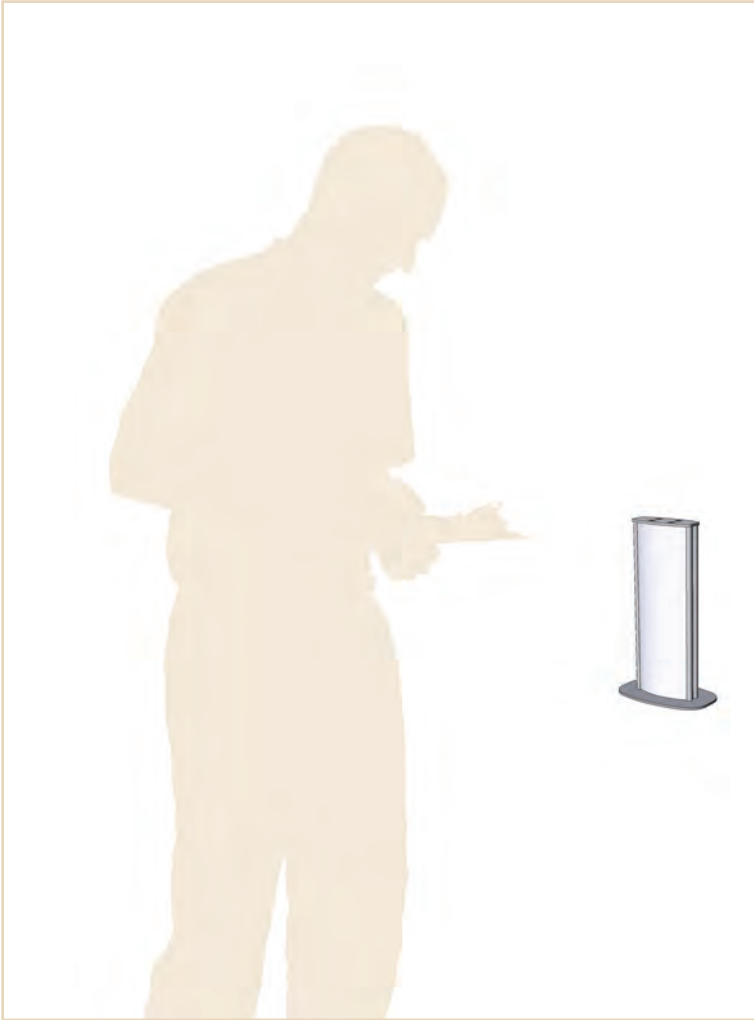

### Computer specifications

#### SECT0032

Overall sign size: H 6" x W 2.4"  
H 154mm x W 60.15mm

Insert size: 5.9" x 2.22" (150mm x 56.5mm)

■ Use a well placed mini pylon for displaying computer specifications near the computers facilities. Updating is quick and easy: just remove the printed insert and replace it with a new one. Braille inserts are supported.



How to burn a CD

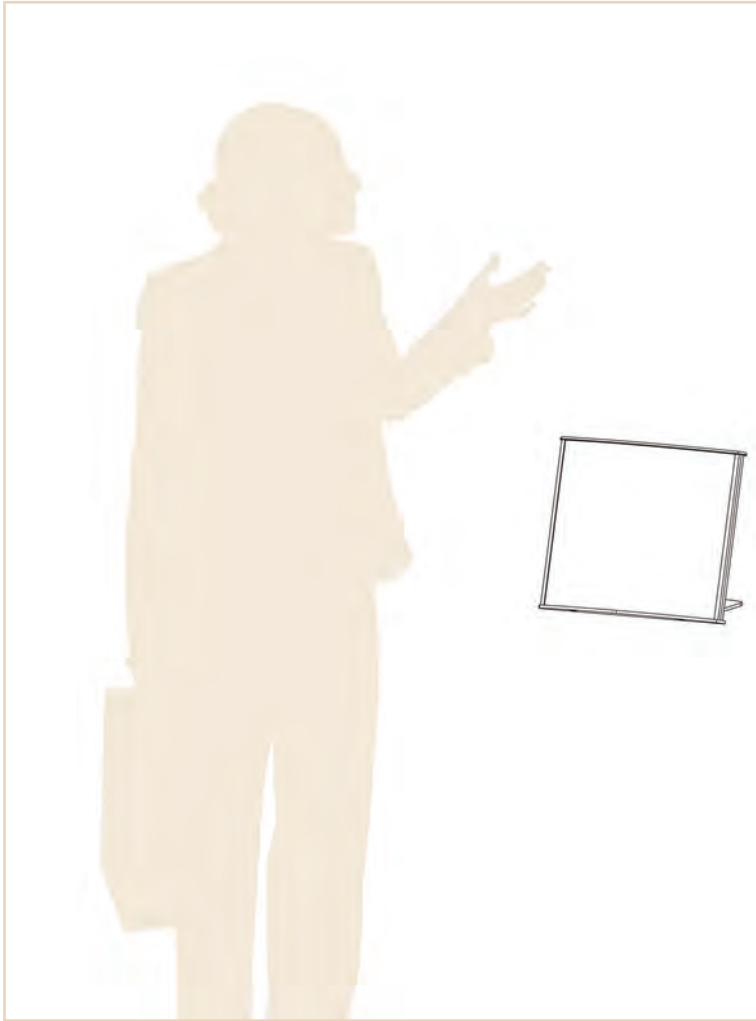

## How to burn a CD

### SECT0069

Overall sign size: H 5.65" x W 8.8"  
H 143.2mm x W 223mm

Insert size: 5.5" x 8.54" (139.7mm x 217mm)

■ Use a well placed table stand for displaying instructions of how to burn a CD on relevant tables in the computers facilities. Updating is quick and easy; you just pop out the printed insert and replace it with a new one.

Vista System is sold only under the brand name "Vista", only to the sign trade. Working this way assures sign makers that Vista System will not compete with them and that the project is done by professionals.

# Magazines

Every library has a magazine area where visitors can review or borrow magazines in various topics. This area should be well organized; the magazines should be displayed clearly so visitors can easily find the right magazine.

Choose the right product for you and order today from your preferred Vista System sign dealer.





Wall mounted magazines display



**Wall mounted magazines display**

**SECT0011**

Overall sign size: H 65.4" x W 51.6"  
H 1660mm x W 1309mm

Insert size: 5.83" x 17.01" (148mm x 432mm)



■ This stand is modular so it can fit any necessity. Each row can be labeled by topic that can be easily updated.

No other curved system can offer such a comprehensive solution, like Vista System.

## Music and Video

Many book libraries feature a CD and DVD area, and of course there are libraries that specialize solely in music and videos. Each section in the music and video department should be clearly identified and labeled. Vista System offers a wide selection of sign types for the music and video department.

Choose the right product for you and order today from your preferred Vista System sign dealer.





Music / Film genre - Flag sign

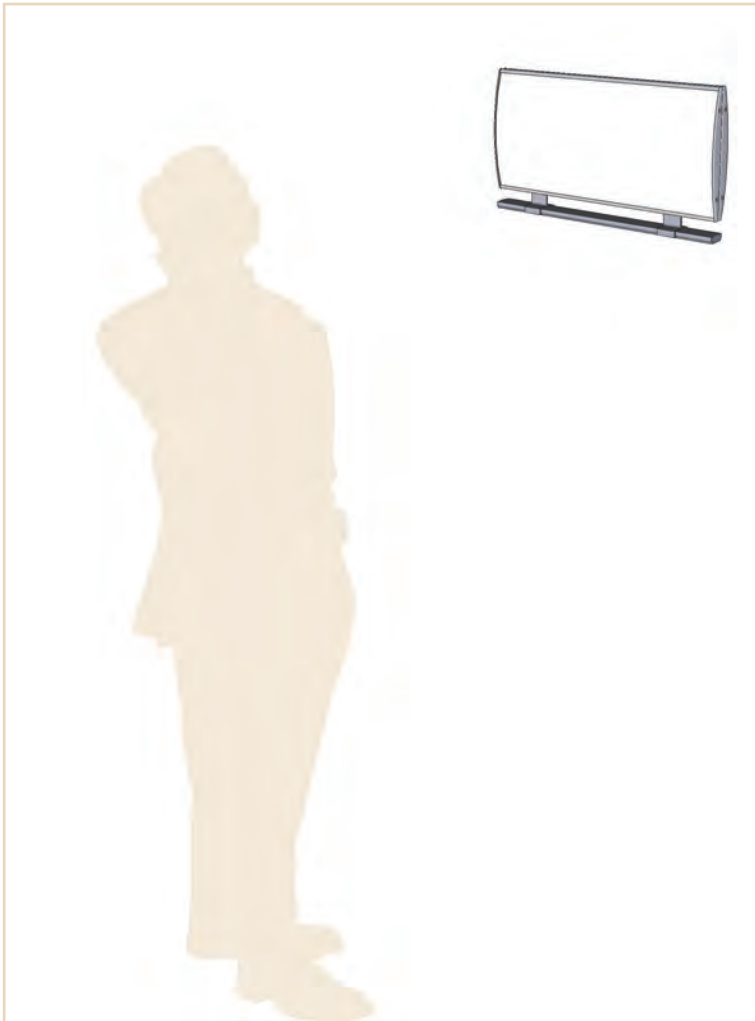

**Music / Film genre - Flag sign**

**SECT0070**

Overall sign size: H 9.2" x W 16"

H 233.1mm x W 406mm

Insert size: 7.68" x 16" x (195mm x 406.4 mm)

■ Use a well placed flag sign to display the music / film genres. The benefit of the flag signs is that they give a needed extra visibility from viewing angles that are not covered by the other signs. Updating is quick and easy; you just pop out the printed insert and replace it with a new one.



Music / Film Genre- Pylon

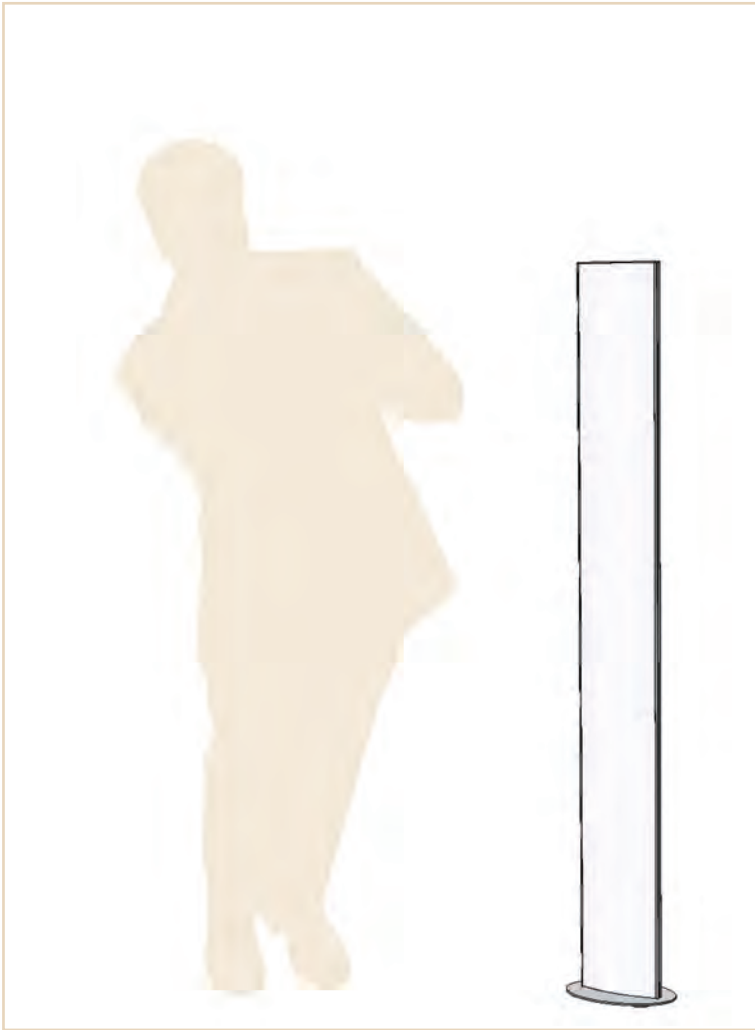

**Music / Film Genre - Pylon**  
**SECT0071**

Overall sign size: H 61.8" x W 7.95"  
H 1569.5mm x W 202mm

Insert size: 61.34" x 7.68" (1558mm x 195mm)



■ Use a well placed double sided pylon to display the music / film genres. Updating is quick and easy; just remove the printed insert and replace it with a new one.



Music / film genre - Suspended



### Music / film genre - Suspended

#### SUS36

Overall sign size: H 11.9" x W 16.7"  
H 301.7mm x W 424mm

Insert size: 11.69" x 16.54" (297mm x 420mm)

■ Use a well placed suspended sign to direct visitors to display the music / film genres. Suspended signs are very flexible; they come in many sizes and types and can be easily mounted to the ceiling. Updating is quick and easy; you just pop out the printed insert and replace it with a new one.



CD's Shelf Divider (Portrait)



**CD's Shelf Divider (Portrait)**

**SECT0033**

Overall sign size: H 5.63" x W 6.6"

H 134mm x W 168mm

Insert size: 4.57" x 1.18" (116mm x 30mm)

■ Use the portrait dividers for CD's when you need to display the labels to the top of the shelf. The dividers are ideal for occasions when you need to divide a long shelf into separate thematic areas. Updating is quick and easy: just remove the printed insert and replace it with a new one. Braille inserts are supported.

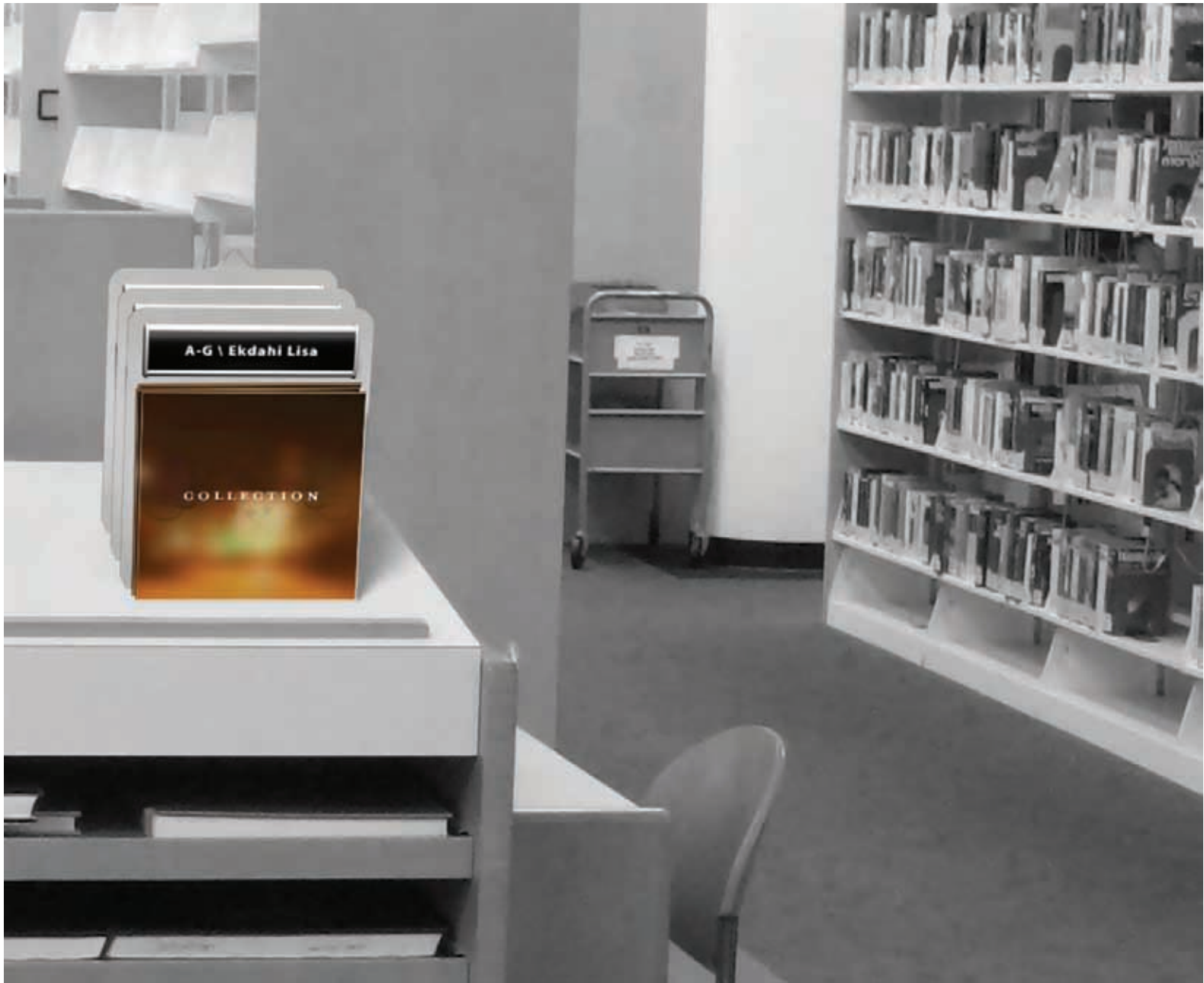

CD's Shelf Divider (Landscape)



### CD's Shelf Divider (Landscape)

**SECT0034**

Overall sign size: H 5.63" x W 6.6"  
H 134mm x W 168mm

Insert size: 4.57" x 1.18" (116mm x 30mm)

■ Use the landscape dividers for CD's when you need to display the labels to the left or right of the shelf. The dividers are ideal for occasions when you need to divide a long shelf into separate thematic areas. Updating is quick and easy: just remove the printed insert and replace it with a new one. Braille inserts are supported.

Vista System offers a revolutionary solution for attaching and installing signs with no need for the welding and/or building of metal construction for support.

## Children's Department

The children's department of the library should be very friendly, colorful, and inviting. As with the usual signage for departments, labeling and wayfinding that are shown in other areas of this website, the children's department should also feature specific signs suitable for the unique characteristics of the department.

Choose the right product for you and order today from your preferred Vista system sign dealer.





Triangular area theme

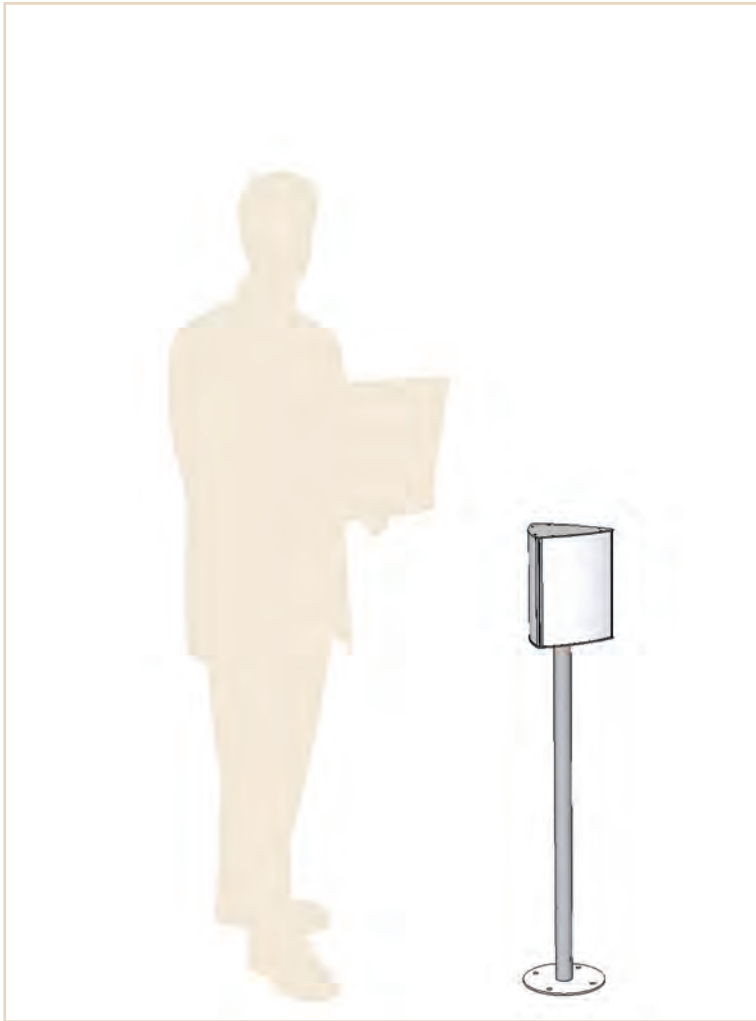

### Triangular area theme

#### TRP3

Overall sign size: H 44" x W 8.3"  
H 1110mm x W 210.6mm

Insert size: 9.84" x 7.8" (250mm x 198mm)



■ Area theme signs are used to introduce each area of the children library in a friendly, clear and colorful fashion. Updating is quick and easy; you just pop out the printed insert and replace it with a new one. Braille inserts are supported.



Recitation Hours

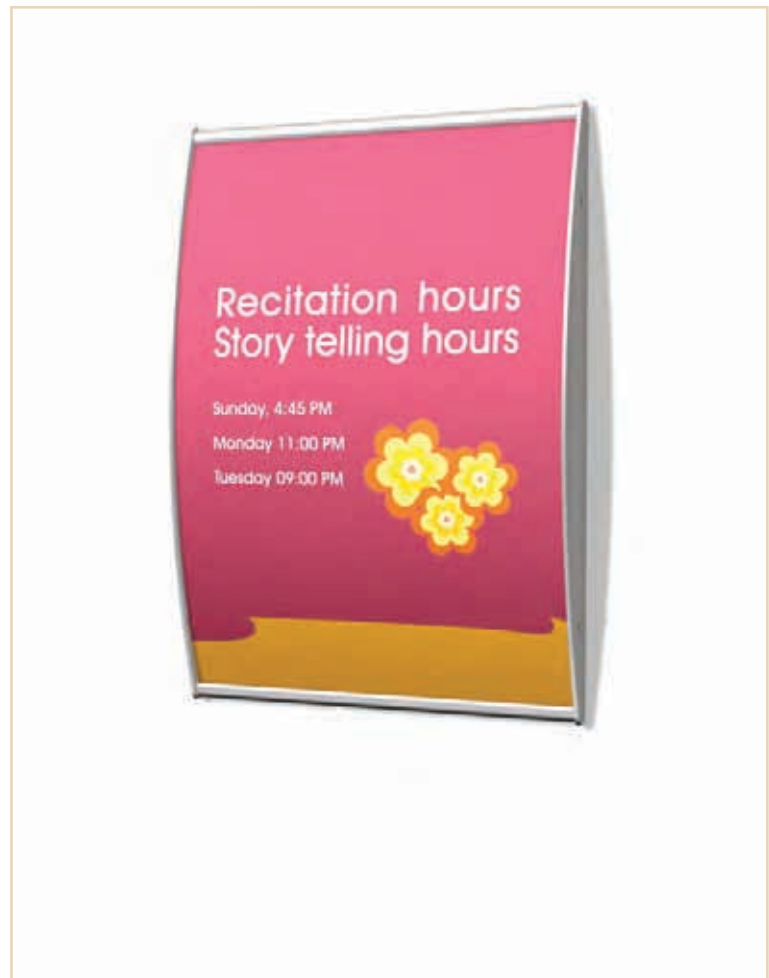
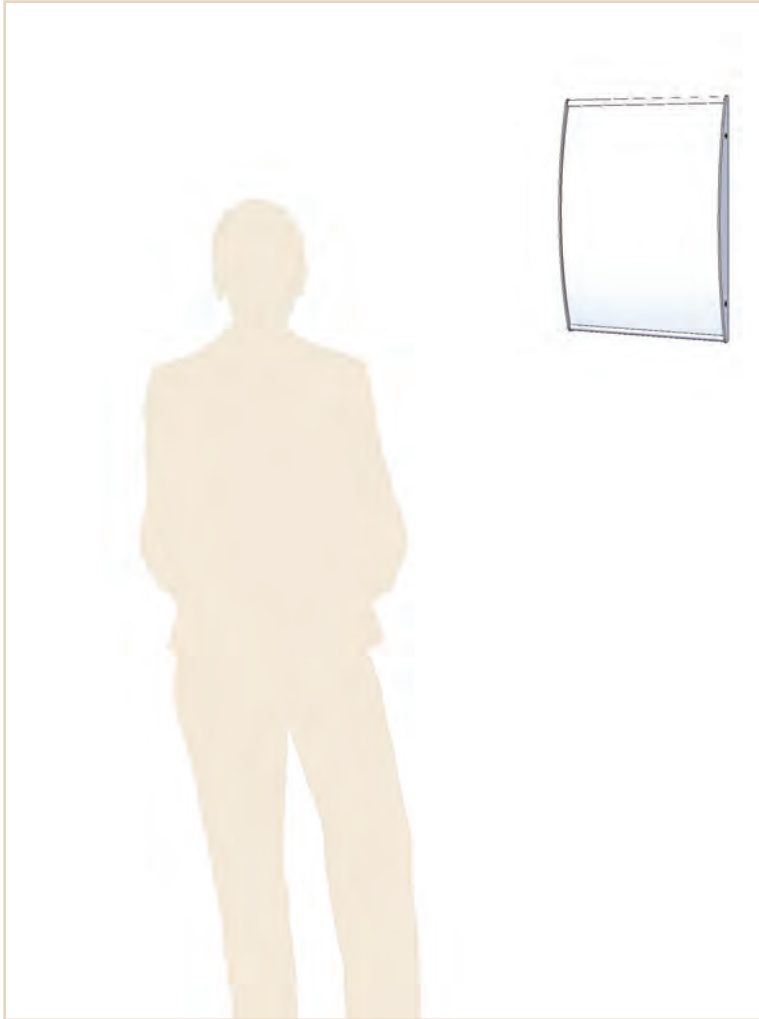

## Recitation Hours

### SECT0075

Overall sign size: H 11.2" x W 8"  
H 284.5mm x W 204mm

Insert size: 10.98" x 7.87" (279mm x 200mm)

■ Use a well placed wall frame to display the recitation hours at the children's department. Updating is quick and easy; just remove the printed insert and replace it with a new one. Braille inserts are supported.



Book Display Stand on Wheels

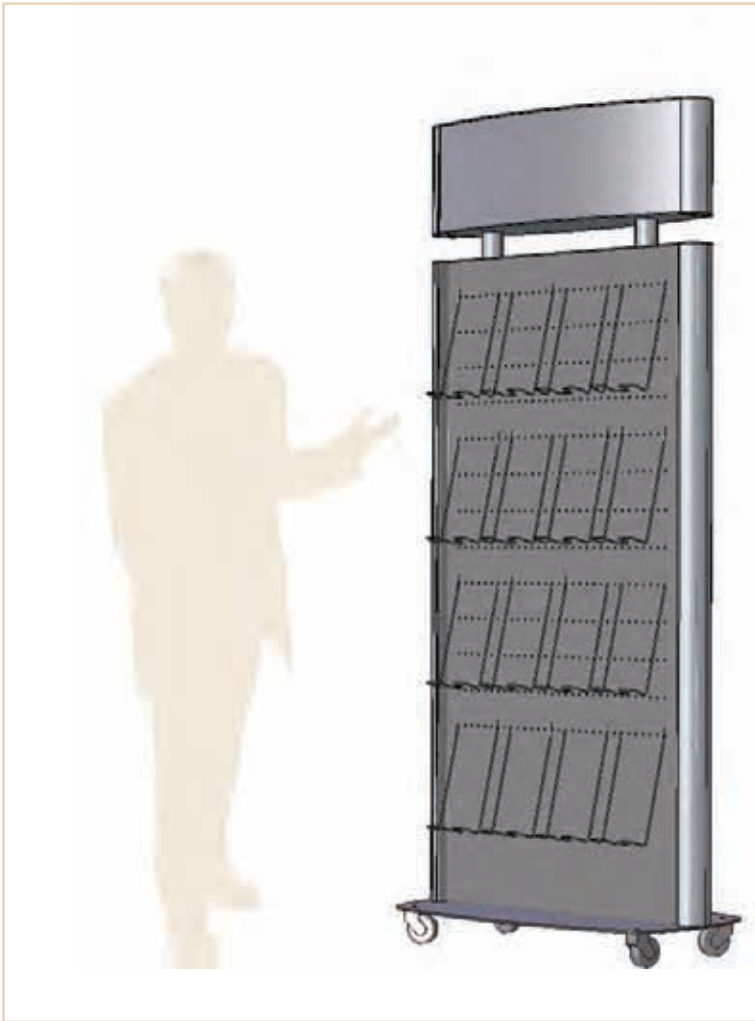

### Book Display Stand on Wheels

#### SECT0035

Overall sign size: H 90" x W 38.7"  
H 2288mm x W 984.6mm

Insert size: 35.51" x 11.81" (902mm x 300mm)



■ A book display stand on wheels is ideal for displaying a large number of books in a central location of the children's department. A book display stand on wheels is often used for displaying new books, selected books for a relevant holiday or event, or books from a specific popular author. Since it is on wheels, this book stand can be easily moved around the department. Updating is quick and easy: just remove the printed insert and replace it with a new one. Braille inserts are supported.

A system of channels for screws inside the extrusion itself, enables the construction of an enormous selection of elements, within minutes and without any welding or special tools.

## Contributors signs

It is very common for libraries to display the names of their contributors in a visible and central location within the library. Vista System offers a wide range of special signage solution for displaying the contributors' names in a respectful and elegant fashion.

Choose the right product for you and order today from your preferred Vista system sign dealer.



# REFERENCE DESK

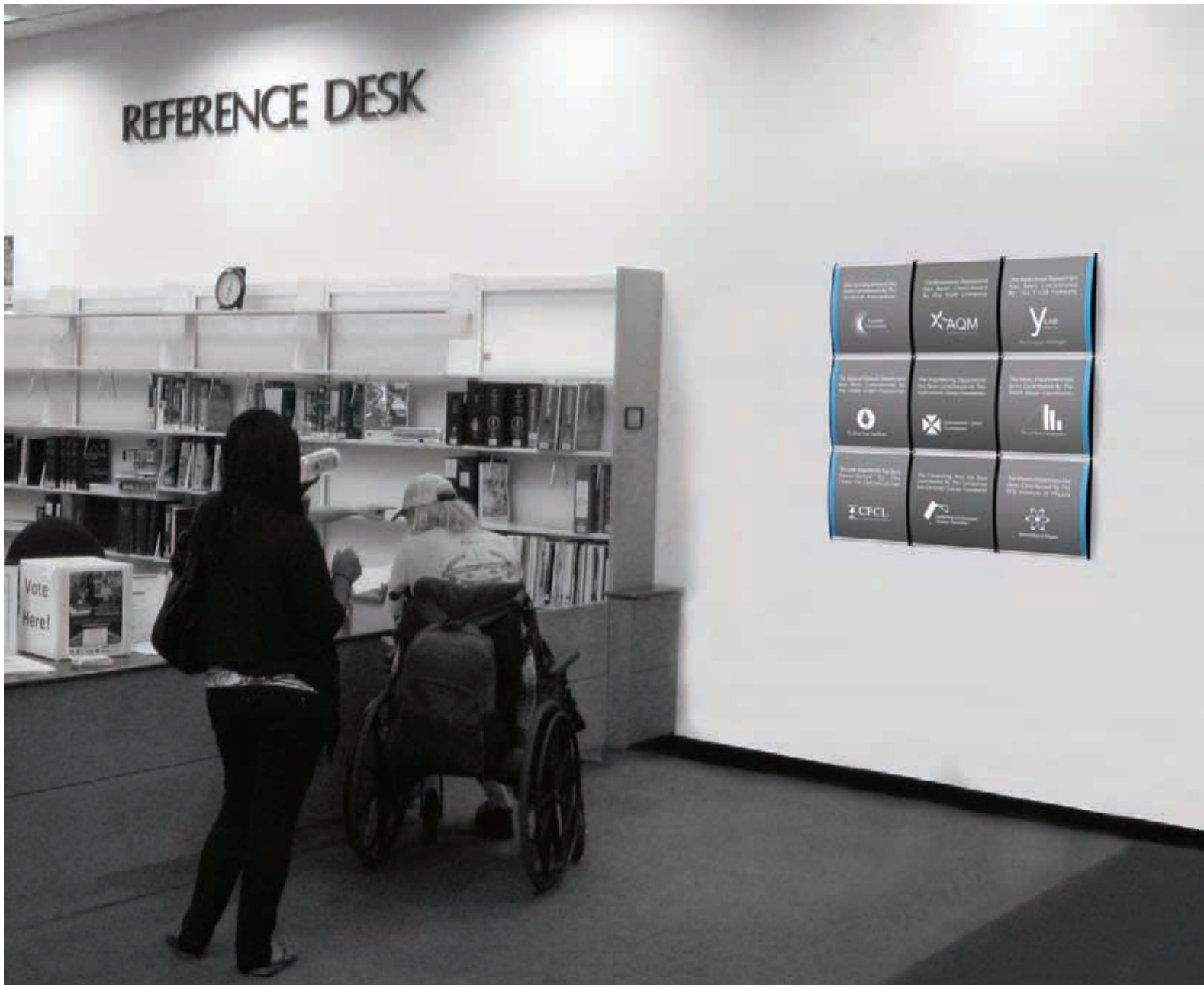

Wall Mounted Contributor Sign

## Contributors signs

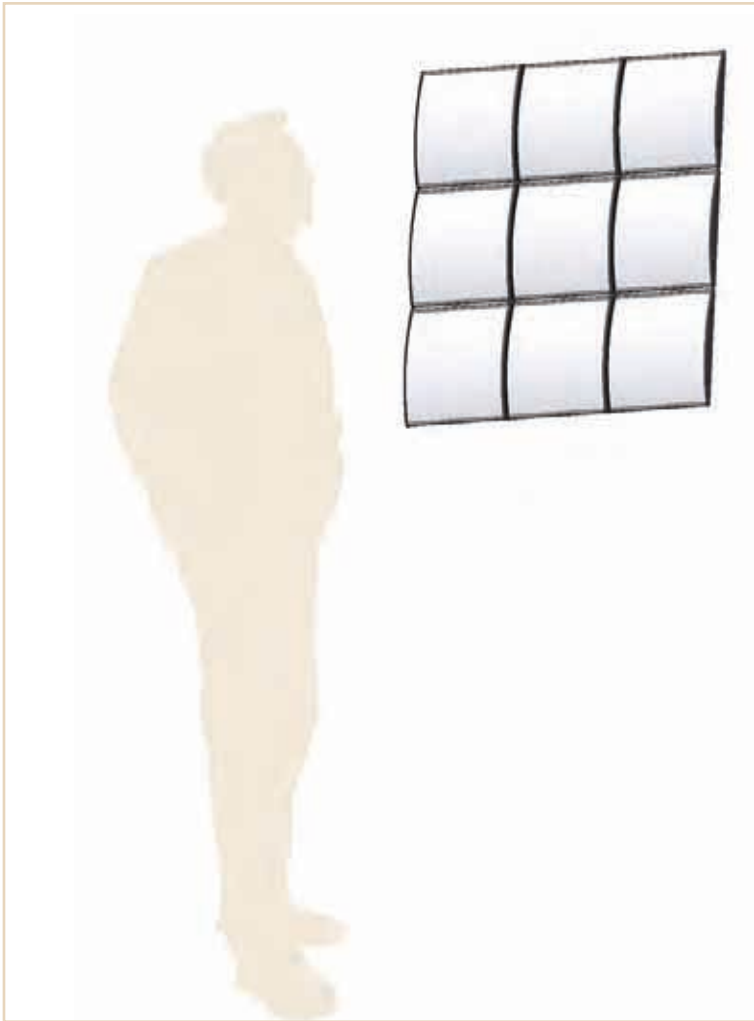

### Wall Mounted Contributor Sign

#### SECT0043

Overall sign size: H 8.5" x W 8.8"  
H 216mm x W 223mm

Insert size: 8.5" x 8.54" (216mm x 217mm)



■ A collection of wall frames combined to create a large display is ideal for displaying the contributors' names. Updating is quick and easy; just remove the printed insert and replace it with a new one. Braille inserts are supported.

# FRIENDS OF

The foundation of this department was made possible by the generous contributions of the following organizations and individuals.

The Art Department Has Been Contributed By:	The Physics Department was built courtesy of:	The Biosciences Department upgrade was made possible by the help of a grant from:
 Mars Technologies	 ODM science promotion fund	 Science Peak Int.
Rita and Ben Brown	Samuel Schneider	Yuri Vitebsky
Garry Douglas	Greg Landman	Nick Harvey
 S-ran Technologies	Phil Pattrick	Paul Pierce
Stephanie Jones	 Fox Industries	Ella Moore
Paula Fitz	Aharon and Mila Goldberg	Gil France
 Dotia Media Ltd	 TriTech	Eve and Adam Gur
 Neo Science	Jon Abdul	 Dotia Media Ltd
Josh Jackson	Will Brown	 Neo Science
Therese Key	Dina Clarence	Ross Short
Benjamin Logan	Nela Atlas	Tom Chambers
Tiffany York	 IGS Technologies	Tony Belzer
Carroll Franklin	David and Gina Fenel	John and Miriam Fox
Shelly Geller	Vladimir Yanilovic	Tim Dumais



Directory Donors

## Contributors signs

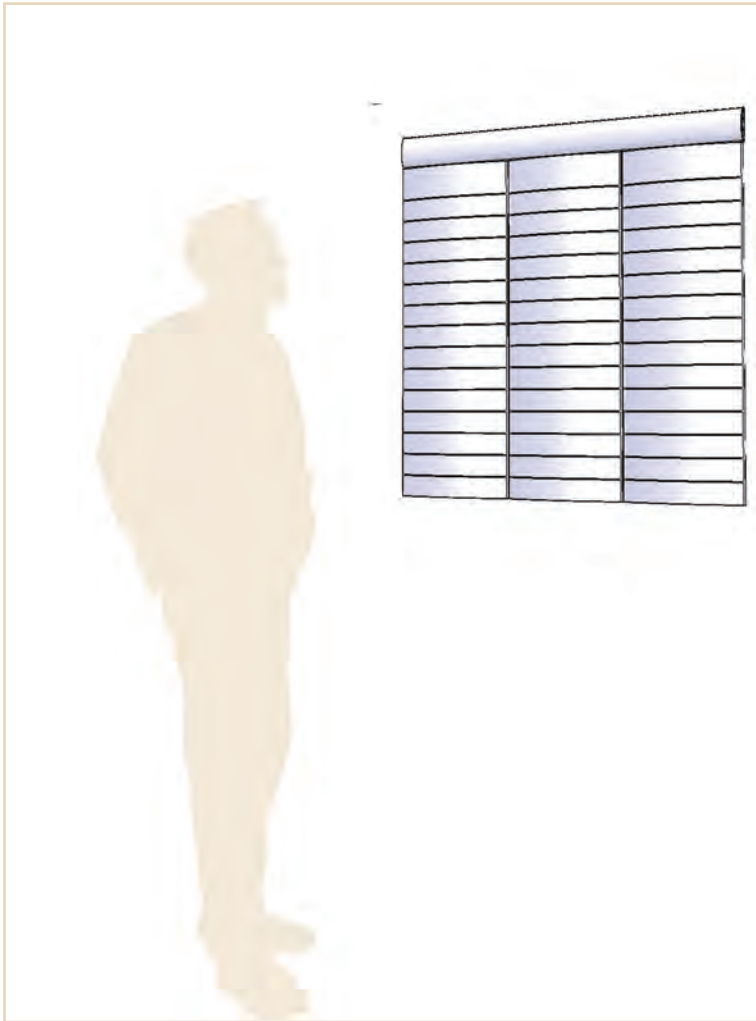

### Directory Donors

#### D35

Overall sign size: H 53.4" x W 47.91"  
H 1217mm x W 1159mm

Insert size: 4" x 47.25", 5" x 15.6", 3" x 15.6" (101.6mm x 1213mm, 127mm x 396mm, 76mm x 396mm)



■ A large wall directory is ideal for displaying many contributors' names. Updating is quick and easy: just remove the printed insert and replace it with a new one. Braille inserts are supported.



Triangular contributors sign

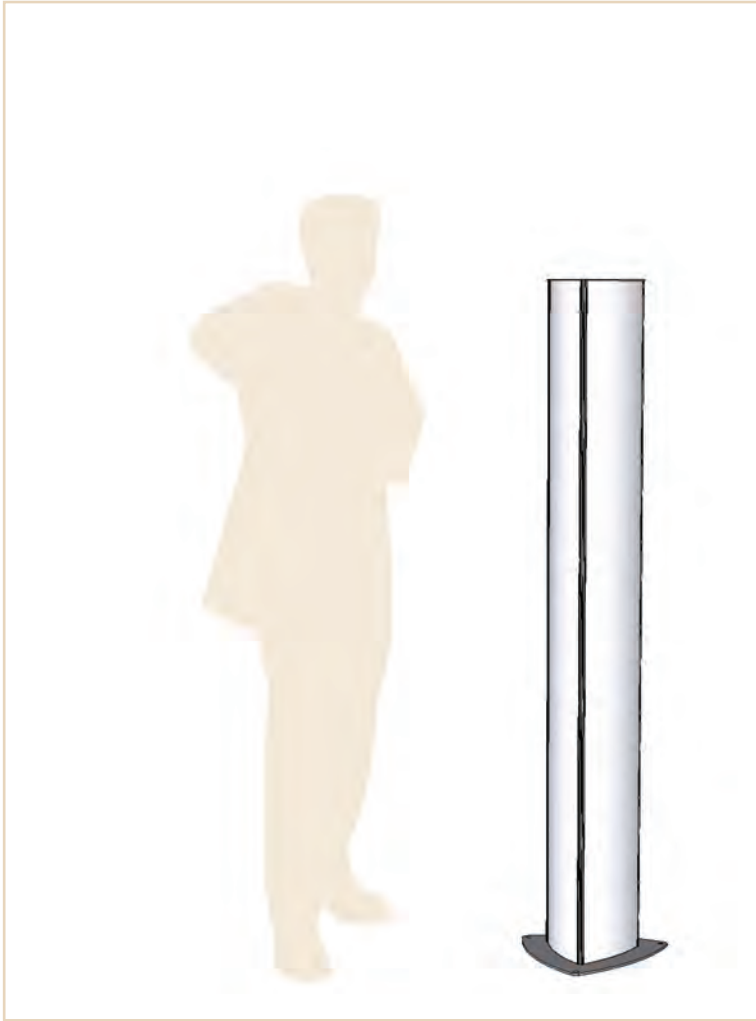

### Triangular contributors sign

#### SECT0044

Overall sign size: H 63" x W 9.1"

H 1600mm x W 231mm

Insert size: 63" x 8.54" (1600mm x 217mm)



■ Use this impressive and elegant triangular pylon to display the contributors' names in a respectable manner. Updating is quick and easy; you just pop out the printed insert and replace it with a new one.



Square contributors sign

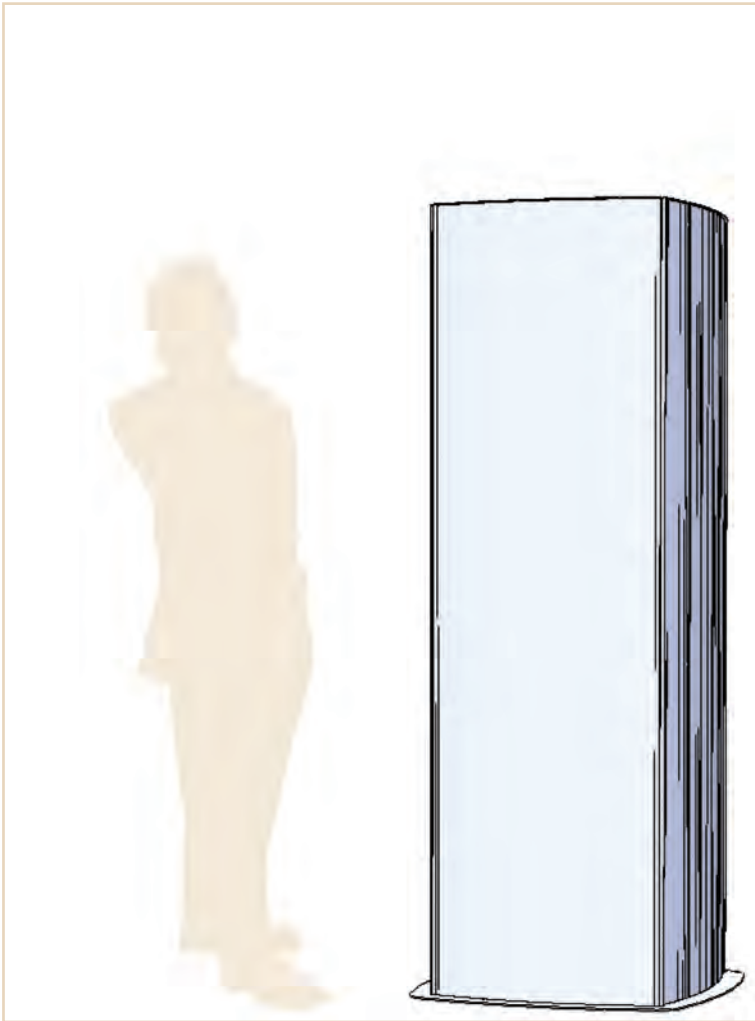

### Square contributors sign

**SECT0045**

Overall sign size: H 78.74" x W 27.33"  
H 2000mm x W 694.5mm

Insert size: 78.74" x 23.62" (2000mm x 600mm)



■ Use this impressive and elegant square pylon to display the contributors' names in a respectable manner. Updating is quick and easy; you just pop out the printed insert and replace it with a new one.

## Tough signs for busy environments

Way finding products located within the reach of a crowd need to be tough. Vandalism frequently leads to damage to the signs. Cleaning staff, often need to use strong detergents and coarse cleaning materials which can also damage the signs.

Vista System utilises state-of-the-art technology to produce sign solutions made from hard anodised Aluminium and powder-coated steel. With MCFT, end caps remain firmly in place thanks to ultra strong screws. All parts are attached together using extremely strong materials without compromising the neat and modern design. Vista system is a frame system; any flat and flexible substrate can be flexed and inserted in to the frame and reinforced to keep it in place! Through simply choosing a tough sign insert, maximum protection is achieved. In rare cases where vandalism to a sign occurs the cost of replacing the insert instead of the whole sign is minimal. The replacement job is fast and easy, even by a novice.





**Vista System**  
We do it your way finding

<http://www.vistasystem.com/Library-Line/index.aspx>